











# Advanced Assembly Assembly Tools



**REAL TOOLS FOR REAL WORK.™**





# Contents

## Electric Fastening Tools

-  **10**  
Cordless Assembly
-  **15**  
DC Electric Nutrunners
-  **32**  
DC Electric Fixtured Spindles
-  **37**  
Fixtured Fastening Systems
-  **38**  
DC Electric Controllers
-  **41**  
ICS Software
-  **47**  
Pulse Tools
-  **51**  
Calibration Equipment



## Accessories

-  **55**  
Spring Balancers
-  **57**  
Torque Reaction Arms & Holders
-  **59**  
Workstations
-  **59, 60**  
Spindle Accessories



## Reference Guides

- 61**  
Torque Table Guide

# Model Identification Guide

### QE Series DC Electric Nutrunners

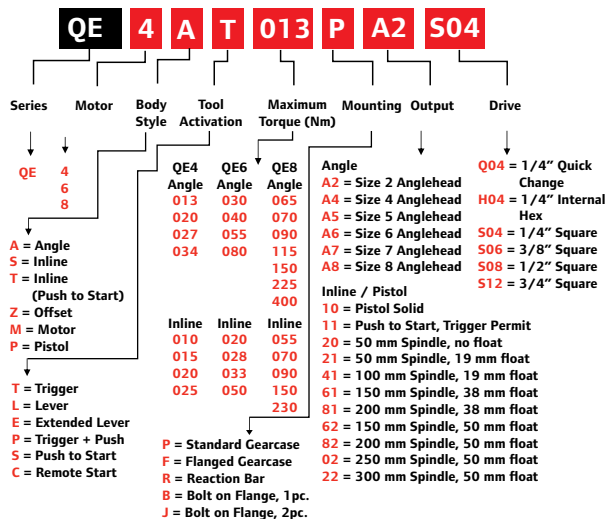

### QE2 Series DC Electric Nutrunners

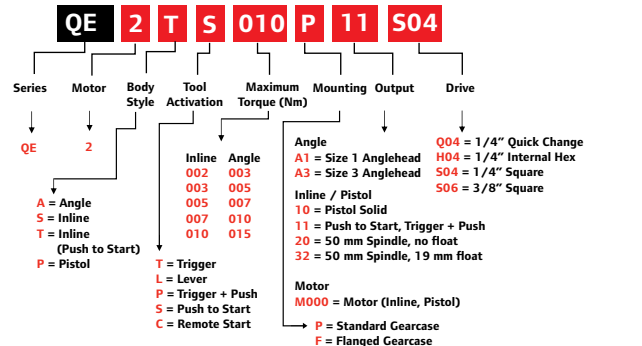

### IC Series DC Electric Controllers

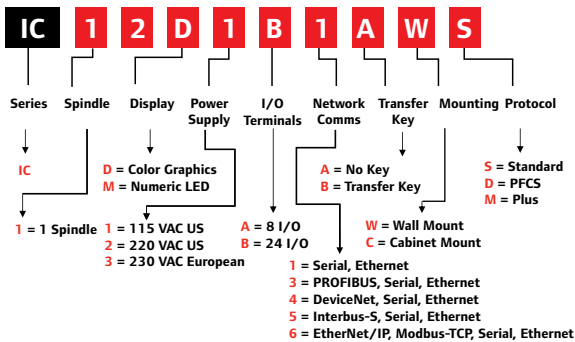



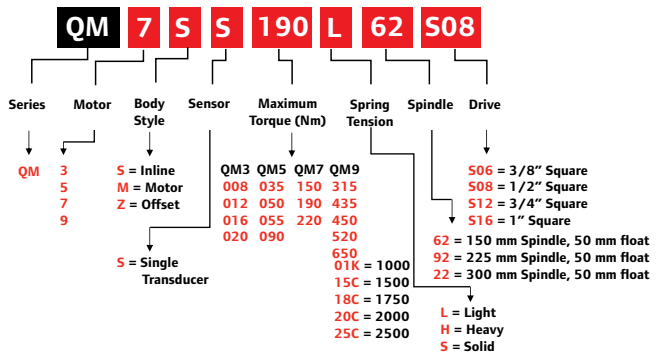





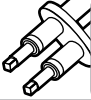

























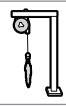





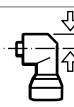





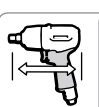









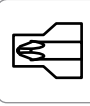

### QM Series DC Electric Spindles



# Technical Symbols

For ease of use, specification tables frequently use symbols in column headings. Please reference the chart below for exact descriptions.

 Fixture fastening systems	 Angle fastening tools	 Bolt capacity	 Tool length
 Voltage	 Angle drills	 Stall torque	 Tool length
 Voltage (BATTERY)	 Fixture fastening tools	 Tool weight	 Tool length
 Spindle accessories	 Torque control system	 Bit holder or Square drive	 Tool length
 Spring balancers	 Reversible models	 Square drive or bit holder	 Tool length
 Pistol grip fastening tools	 Non-reversible models	 Square drive or bit holder	 Sound level
 Pistol grip drills	 Torque range	 Floating spindle stroke	 Working stations
 Straight fastening tools	 Wireless/USB Communications	 Hose min. internal diameter	 Other accessories
 Tool length	 Side-to-center distance	 Spindle length	 Torque reaction arms & holders
 Tool length	 Angle head height	 Spindle length	 ICS software
 Tool length	 Nominal load capacity	 Square drive	 Calibration equipment
 Side-to-center distance	 Size	 1/4" hex quick change	 Parts manual
 Side-to-center distance	 Number of tools controlled	 1/4" hex bit holder (requires bit guide or finder)	 Product information manual
 Side-to-center distance	 Standard height of lift	 1/4" hex bit holder	 Maintenance information manual
 Cordless Precision Tools	 Max. free speed	 1/4" hex insert bit holder	 Operation and maintenance manual

# Torque Selection Guides

## Cordless Precision Tools

### Torque Selection Guide

Pistol Trigger Start	Model	0	6 Nm	12 Nm	18 Nm	24 Nm	30 Nm	Referral Page
		▼	▼	▼	▼	▼	▼	
	QXX2PT04P...		█					10
	QXX2PT08P...		█	█				10
	QXX2PT12P...		█	█	█			10
	QXX2PT18P...		█	█	█	█		10
	QXC2PT04P...		█					10
	QXC2PT08P...		█	█				10
	QXC2PT12P...		█	█	█			10
	QXC2PT18P...		█	█	█	█		10

Pistol Trigger Start	Model	0	6 Nm	12 Nm	18 Nm	24 Nm	30 Nm	Referral Page
		▼	▼	▼	▼	▼	▼	
	QXX2PT04V...		█					11
	QXX2PT08V...		█	█				11
	QXX2PT12V...		█	█	█			11
	QXC2PT04V...		█					11
	QXC2PT08V...		█	█				11
	QXC2PT12V...		█	█	█			11

Angle Trigger Start	Model	0	6 Nm	12 Nm	18 Nm	24 Nm	30 Nm	Referral Page
		▼	▼	▼	▼	▼	▼	
	QXX2AT05PQ4		█					11
	QXX2AT10PS6		█	█				11
	QXX2AT15PS6		█	█	█			11
	QXX2AT18PQ4		█	█	█	█		11
	QXX2AT18PS6		█	█	█	█		11
	QXX2AT27PS6		█	█	█	█	█	11
	QXC2AT05PQ4		█					11
	QXC2AT10PS6		█	█				11
	QXC2AT15PS6		█	█	█			11
	QXC2AT18PQ4		█	█	█	█		11
	QXC2AT18PS6		█	█	█	█		11
	QXC2AT27PS6		█	█	█	█	█	11

## DC Electric Screwdriver

### Torque Selection Guide

Inline Push-to-Start	Model	0	1 Nm	5 Nm	10 Nm	Referral Page
		▼	▼	▼	▼	
	QE2TS002P11...		█			13
	QE2TS003P11...		█	█		13
	QE2TS005P11...		█	█	█	13
	QE2TS007P11...		█	█	█	13
	QE2TS010P11...		█	█	█	13

Inline Lever Start	Model	0	1 Nm	5 Nm	10 Nm	Referral Page
		▼	▼	▼	▼	
	QE2SL002P10...		█			14
	QE2SL002F32S06		█			14
	QE2SL003P10...		█	█		14
	QE2SL003F32S06		█	█		14
	QE2SL005P10...		█	█	█	14
	QE2SL005F32S06		█	█	█	14
	QE2SL007P10...		█	█	█	14
	QE2SL007F32S06		█	█	█	14
	QE2SL010P10...		█	█	█	14
	QE2SL010F32S06		█	█	█	14

# DC Electric Screwdriver

## Torque Selection Guide

Inline Lever +  
Push-to-Start

Model	0	1 Nm	5 Nm	10 Nm	Referral Page
QE2SP002P11...		█			14
QE2SP003P11...		█	█		14
QE2SP005P11...		█	█	█	14
QE2SP007P11...		█	█	█	14
QE2SP010P11...		█	█	█	14

Inline  
Remote Start

Model	0	1 Nm	5 Nm	10 Nm	Referral Page
QE2SC002F32S06		█			14
QE2SC003F32S06		█	█		14
QE2SC005F32S06		█	█	█	14
QE2SC007F32S06		█	█	█	14
QE2SC010F32S06		█	█	█	14



# DC Electric Nutrunners

## Torque Selection Guide

Pistol  
Push-to-Start

Model	0	1 Nm	5 Nm	10 Nm	Referral Page
QE2PS002P11...		█			15
QE2PS003P11...		█	█		15
QE2PS005P11...		█	█	█	15
QE2PS007P11...		█	█	█	15
QE2PS010P11...		█	█	█	15

Pistol  
Trigger Start

Model	0	1 Nm	5 Nm	10 Nm	Referral Page
QE2PT002P10...		█			16
QE2PT003P10...		█	█		16
QE2PT005P10...		█	█	█	16
QE2PT007P10...		█	█	█	16
QE2PT010P10...		█	█	█	16

Pistol  
Trigger +  
Push-to-Start

Model	0	1 Nm	5 Nm	10 Nm	Referral Page
QE2PP002P11...		█			16
QE2PP003P11...		█	█		16
QE2PP005P11...		█	█	█	16
QE2PP007P11...		█	█	█	16
QE2PP010P11...		█	█	█	16

# DC Electric Nutrunners

## Torque Selection Guide



Angle  
Lever Start

Model	0	1 Nm	5 Nm	10 Nm	15 Nm	Referral Page
QE2AL003PA1S04		█				17
QE2AL005PA3...		█	█			17
QE2AL007PA3...		█	█	█		17
QE2AL010PA3...		█	█	█	█	18
QE2AL015PA3...		█	█	█	█	18



# DC Electric Nutrunners

## Torque Selection Guide

Inline Motor Push-to-Start	Model	0	1 Nm	5 Nm	10 Nm	15 Nm	Referral Page
		▼	▼	▼	▼	▼	
	QE2TS002PM0		█				19
	QE2TS003PM0		█	█			19
	QE2TS005PM0		█	█	█		19
	QE2TS007PM0		█	█	█	█	19
	QE2TS010PM0		█	█	█	█	19

Inline Motor Lever Start	Model	0	1 Nm	5 Nm	10 Nm	15 Nm	Referral Page
		▼	▼	▼	▼	▼	
	QE2SL002PM0		█				19
	QE2SL003PM0		█	█			19
	QE2SL005PM0		█	█	█		19
	QE2SL007PM0		█	█	█	█	19
	QE2SL010PM0		█	█	█	█	19

Inline Motor Push-to-Start	Model	0	1 Nm	5 Nm	10 Nm	15 Nm	Referral Page
		▼	▼	▼	▼	▼	
	QE2SP002PM0		█				20
	QE2SP003PM0		█	█			20
	QE2SP005PM0		█	█	█		20
	QE2SP007PM0		█	█	█	█	20
	QE2SP010PM0		█	█	█	█	20

Inline Motor Push-to-Start	Model	0	1 Nm	5 Nm	10 Nm	15 Nm	Referral Page
		▼	▼	▼	▼	▼	
	QE2PS002PM0		█				20
	QE2PS003PM0		█	█			20
	QE2PS005PM0		█	█	█		20
	QE2PS007PM0		█	█	█	█	20
	QE2PS010PM0		█	█	█	█	20

Pistol Motor Trigger Start	Model	0	1 Nm	5 Nm	10 Nm	15 Nm	Referral Page
		▼	▼	▼	▼	▼	
	QE2PT002PM0		█				20
	QE2PT003PM0		█	█			20
	QE2PT005PM0		█	█	█		20
	QE2PT007PM0		█	█	█	█	20
	QE2PT010PM0		█	█	█	█	20

Pistol Motor Trigger + Push-to-Start	Model	0	1 Nm	5 Nm	10 Nm	15 Nm	Referral Page
		▼	▼	▼	▼	▼	
	QE2PP002PM0		█				20
	QE2PP003PM0		█	█			20
	QE2PP005PM0		█	█	█		20
	QE2PP007PM0		█	█	█	█	20
	QE2PP010PM0		█	█	█	█	20



# DC Electric Nutrunners

## Torque Selection Guide

Inline Push-to-Start	Model	0	5 Nm	10 Nm	15 Nm	20 Nm	25 Nm	Referral Page
	QE4TS010R11...							
QE4TS015R11...								21
QE4TS020R11...								21
QE4TS025R11...								21

Pistol Trigger + Push-to-Start	Model	0	5 Nm	10 Nm	15 Nm	20 Nm	25 Nm	Referral Page
	QE4PP010P11...							
QE4PP015P11...								22
QE4PP020P11...								22
QE4PP025P11...								22

Pistol Push-to-Start	Model	0	5 Nm	10 Nm	15 Nm	20 Nm	25 Nm	Referral Page
	QE4PS010P11...							
QE4PS015P11...								23
QE4PS020P11...								23
QE4PS025P11...								23

Pistol Trigger Start	Model	0	5 Nm	10 Nm	15 Nm	20 Nm	25 Nm	Referral Page
	QE4PT010P10...							
QE4PT015P10...								23
QE4PT020P10...								23
QE4PT025P10...								23

Inline	Model	0	20 Nm	40 Nm	60 Nm	80 Nm	100 Nm	150 Nm	200 Nm	250 Nm	Referral Page
	QE4ST010B...										
QE4ST015B...											24,25
QE4ST020B...											25
QE4ST025B...											25
QE6ST020F...											26
QE6ST028F...											26
QE6ST033F...											26
QE6ST050F...											26
QE8ST055F...											27
QE8ST070F...											27
QE8ST090F...											27
QE8ST150F...											27
QE8ST230F...											27

Inline Offset	Model	0	50 Nm	100 Nm	150 Nm	200 Nm	Referral Page
	QE6ZC020...						
QE6ZC028...							28
QE6ZC033...							28
QE6ZC050...							28
QE8ZC055...							29
QE8ZC070...							29
QE8ZC090...							29
QE8ZC150...							29



Angle

## DC Electric Nutrunners

### Torque Selection Guide

Model	0	20 Nm	40 Nm	60 Nm	80 Nm	100 Nm	200 Nm	300 Nm	400 Nm	Referral Page
QE4AT013P...										30
QE4AT020P...										30
QE4AT027P...										30
QE4AT034P...										30
QE6AT030P...										31
QE6AT040P...										31
QE6AT055P...										31
QE6AT080P...										31
QE8AT065P...										31
QE6AT070P...										31
QE8AT090P...										31
QE8AT115P...										31
QE8AT150P...										31
QE8AT225P...										31
QE8AT400P...										31



Inline

## DC Electric Fixtured Spindles

### Torque Selection Guide

Model	0	20 Nm	40 Nm	60 Nm	80 Nm	100 Nm	250 Nm	500 Nm	1000 Nm	1500 Nm	2000 Nm	2500 Nm	Referral Page
QM3SS008...													32
QM3SS012...													32
QM3SS016...													32
QM3SS020...													32
QM5SS035...													33
QM5SS055...													33
QM5SS090...													33
QM7SS190...													33
QM7SS220...													33
QM9SS315...													34
QM9SS435...													34
QM9SS520...													34
QM9SS650...													34
QM9SS01K...													34
QM9SS15C...													34
QM9SS18C...													34
QM9SS20C...													34
QM9SS25C...													34

Offset

Model	0	50 Nm	100 Nm	150 Nm	200 Nm	250 Nm	300 Nm	350 Nm	400 Nm	450 Nm	Referral Page
QM5ZS035...											35
QM5ZS050...											35
QM7ZS150...											35
QM9ZS315...											35
QM9ZS435...											35
QM9ZS450...											35



# Pulse Tools

## Torque Selection Guide

Transducerized  
Trigger Start



Model	0	30 Nm	60 Nm	90 Nm	120 Nm	150 Nm	180 Nm	210 Nm	240 Nm	Referral Page
QXP60Q4	█									47
QXP70Q4	█	█								47
QXP60P6	█	█	█							47
QXP70P6	█	█	█	█						47
QXP80P6	█	█	█	█	█					47
QXP90P6	█	█	█	█	█	█				47
QXP110P8	█	█	█	█	█	█	█			47
QXP120P8	█	█	█	█	█	█	█	█		47
QXP140P8	█	█	█	█	█	█	█	█	█	47
QXP150P8	█	█	█	█	█	█	█	█	█	47

Transducerized  
Trigger Start  
(Angle Encoded)

Model	0	20 Nm	40 Nm	60 Nm	80 Nm	100 Nm	120 Nm	140 Nm	160 Nm	Referral Page
QXP600Q4	█									47
QXP700Q4	█	█								47
QXP600P6	█	█	█							47
QXP700P6	█	█	█	█						47
QXP900P6	█	█	█	█	█					47
QXP1100P8	█	█	█	█	█	█				47
QXP1400P8	█	█	█	█	█	█	█	█	█	47

Transducerized  
Classic Series



Model	0	60 Nm	120 Nm	180 Nm	240 Nm	300 Nm	360 Nm	Referral Page
YEX-120A	█							48
YEX-120	█	█						48
YEX-150A	█	█	█					48
YEX-150	█	█	█	█				48
YEX-501A	█	█	█	█				48
YEX-501	█	█	█	█	█			48
YEX-701	█	█	█	█	█			48
YEX-901	█	█	█	█	█	█		48
YEX-1400	█	█	█	█	█	█		48
YEX-1900	█	█	█	█	█	█	█	48
YEX-3000	█	█	█	█	█	█	█	48
YED-200	█	█	█	█	█	█	█	48

Transducerized  
Classic Series



Model	0	10 Nm	20 Nm	30 Nm	40 Nm	50 Nm	60 Nm	Referral Page
YEX-120SA	█							49
YEX-120S	█	█						49
YEX-150SA	█	█	█					49
YEX-150S	█	█	█	█				49
YEX-300SA	█	█	█	█	█			49
YEX-300S	█	█	█	█	█	█		49
YEX-500SA	█	█	█	█	█	█		49
YEX-500S	█	█	█	█	█	█	█	49
YEX-700S	█	█	█	█	█	█	█	49

# Cordless Precision Screwdriver

Pistol

## QX Series

Building on the Ingersoll Rand legacy for unmatched quality and durability, the innovative QX Series cordless precision screwdriver elevates tool performance to new heights. Its advanced feature set is engineered to meet your needs, now and in the future—at a price you can afford today. It will quickly become the most valuable tool on your assembly line.

### Features

- Multi-function display module and password protected keypad offer quick setup and visual feedback—right on the tool
- Eight user-programmable torque/angle/speed configurations allow one tool to do the job of up to eight, reducing tool costs and workspace clutter
- Closed-loop transducer control ensures quick assembly, precise torque and accurate, traceable results
- Compact, cordless assembly tool gives you the freedom to work without constraints
- Lightweight, low-reaction, ergonomically balanced design maximizes operator comfort
- Advanced programming for prevailing torque tier compensation and multi-step fastening
- Safe and clean operation – no cords, air hoses or brush dust
- Wireless communication option delivers process control with I/O, remote configuration switching and real-time data archiving for up to 10 tools via Process Communication Module (PCM)
- Plant-wide networking manages both process control inputs and feedback data using Ethernet, Fieldbus or I/O, complete with data archiving

































QX

Battery sold separately

### Service and Accessories

VP1-Boot, Bit Selector Tray, Socket Selector Tray, Communications Kit, Suspension Bale, Auxiliary Handle, Selector Tray Cables, Torque Tester, Spring Balancer, Socket Kit





















Model	 in-lbs (Nm)	 rpm	 lbs (kg)	 in (mm)	 in (mm)	 in	 V	 Communications
<b>DC TRIGGER START</b>								
QXX2PT04PQ4	7 - 35 (0.8 - 4)	1500	2.0 (0.91)	8.48 (215.4)	0.8 - 1 (20 - 26)	1/4" 	20V Li-ion	Wireless Enabled
QXX2PT04PS4	7 - 35 (0.8 - 4)	1500	2.0 (0.91)	8.20 (208.3)	0.8 - 1 (20 - 26)	1/4" 	20V Li-ion	Wireless Enabled
QXX2PT04PS6	7 - 35 (0.8 - 4)	1500	2.0 (0.91)	8.35 (212)	0.8 - 1(20 - 26)	3/8" 	20V Li-ion	Wireless Enabled
QXX2PT08PQ4	14 - 70 (1.6 - 8)	1150	2.0 (0.91)	8.48 (215.4)	0.8 - 1(20 - 26)	1/4" 	20V Li-ion	Wireless Enabled
QXX2PT08PS4	14 - 70 (1.6 - 8)	1150	2.0 (0.91)	8.20 (208.3)	0.8 - 1(20 - 26)	1/4" 	20V Li-ion	Wireless Enabled
QXX2PT08PS6	14 - 70 (1.6 - 8)	1150	2.0 (0.91)	8.35 (212)	0.8 - 1(20 - 26)	3/8" 	20V Li-ion	Wireless Enabled
QXX2PT12PQ4	21 - 106 (2.4 - 12)	750	2.0 (0.91)	8.48 (215.4)	0.8 - 1(20 - 26)	1/4" 	20V Li-ion	Wireless Enabled
QXX2PT12PS4	21 - 106 (2.4 - 12)	750	2.0 (0.91)	8.20 (208.3)	0.8 - 1(20 - 26)	1/4" 	20V Li-ion	Wireless Enabled
QXX2PT12PS6	21 - 106 (2.4 - 12)	750	2.0 (0.91)	8.35 (212)	0.8 - 1(20 - 26)	3/8" 	20V Li-ion	Wireless Enabled
QXX2PT18PQ4	32 - 159 (3.6 - 18)	500	2.0 (0.91)	8.48 (215.4)	0.8 - 1(20 - 26)	1/4" 	20V Li-ion	Wireless Enabled
QXX2PT18PS6	32 - 159 (3.6 - 18)	500	2.0 (0.91)	8.35 (212)	0.8 - 1(20 - 26)	3/8" 	20V Li-ion	Wireless Enabled
QXC2PT04PQ4	7 - 35 (0.8 - 4)	1500	2.0 (0.91)	8.48 (215.4)	0.8 - 1 (20 - 26)	1/4" 	20V Li-ion	USB Only
QXC2PT04PS4	7 - 35 (0.8 - 4)	1500	2.0 (0.91)	8.20 (208.3)	0.8 - 1 (20 - 26)	1/4" 	20V Li-ion	USB Only
QXC2PT04PS6	7 - 35 (0.8 - 4)	1500	2.0 (0.91)	8.35 (212)	0.8 - 1(20 - 26)	3/8" 	20V Li-ion	USB Only
QXC2PT08PQ4	14 - 70 (1.6 - 8)	1150	2.0 (0.91)	8.48 (215.4)	0.8 - 1(20 - 26)	1/4" 	20V Li-ion	USB Only
QXC2PT08PS4	14 - 70 (1.6 - 8)	1150	2.0 (0.91)	8.20 (208.3)	0.8 - 1(20 - 26)	1/4" 	20V Li-ion	USB Only
QXC2PT08PS6	14 - 70 (1.6 - 8)	1150	2.0 (0.91)	8.35 (212)	0.8 - 1(20 - 26)	3/8" 	20V Li-ion	USB Only
QXC2PT12PQ4	21 - 106 (2.4 - 12)	750	2.0 (0.91)	8.48 (215.4)	0.8 - 1(20 - 26)	1/4" 	20V Li-ion	USB Only
QXC2PT12PS4	21 - 106 (2.4 - 12)	750	2.0 (0.91)	8.20 (208.3)	0.8 - 1(20 - 26)	1/4" 	20V Li-ion	USB Only
QXC2PT12PS6	21 - 106 (2.4 - 12)	750	2.0 (0.91)	8.35 (212)	0.8 - 1(20 - 26)	3/8" 	20V Li-ion	USB Only
QXC2PT18PQ4	32 - 159 (3.6 - 18)	500	2.0 (0.91)	8.48 (215.4)	0.8 - 1(20 - 26)	1/4" 	20V Li-ion	USB Only
QXC2PT18PS6	32 - 159 (3.6 - 18)	500	2.0 (0.91)	8.35 (212)	0.8 - 1(20 - 26)	3/8" 	20V Li-ion	USB Only

# Cordless Precision Haz Tool

## Pistol

The CLASS 1 DIVISION 2 CERTIFIED QX Series Haz Tool takes the QX series where it couldn't go before. It's a revolutionary step for your entire facility, one that shows how a smarter tool can improve process control, operator comfort and data communication in a single safe package while increasing productivity, lowering costs and ensuring a high-quality product at the end of your line. The future of assembly tools is one that puts you in total control.























Model	 in-lbs (Nm)	 rpm	 lbs (kg)	 in (mm)	 in (mm)	 in	 V	 Communications
<b>DC TRIGGER START</b>								
QXX2PT04VQ4	7 - 35 (0.8 - 4)	1500	2.0 (0.91)	8.48 215.4	0.8 - 1(20 - 26)	1/4" 	20V Li-ion	Wireless Enabled
QXX2PT04VS6	7 - 35 (0.8 - 4)	1500	2.0 (0.91)	8.35 212.0	0.8 - 1(20 - 26)	3/8" 	20V Li-ion	Wireless Enabled
QXX2PT08VQ4	14 - 70 (1.6 - 8)	1150	2.0 (0.91)	8.48 215.4	0.8 - 1(20 - 26)	1/4" 	20V Li-ion	Wireless Enabled
QXX2PT08VS6	14 - 70 (1.6 - 8)	1150	2.0 (0.91)	8.35 212.0	0.8 - 1(20 - 26)	3/8" 	20V Li-ion	Wireless Enabled
QXX2PT12VQ4	21 - 106 (2.4 - 12)	750	2.0 (0.91)	8.48 215.4	0.8 - 1(20 - 26)	1/4" 	20V Li-ion	Wireless Enabled
QXX2PT12VS6	21 - 106 (2.4 - 12)	750	2.0 (0.91)	8.35 212.0	0.8 - 1(20 - 26)	3/8" 	20V Li-ion	Wireless Enabled
QXC2PT04VQ4	7 - 35 (0.8 - 4)	1500	2.0 (0.91)	8.48 215.4	0.8 - 1(20 - 26)	1/4" 	20V Li-ion	USB Only
QXC2PT04VS6	7 - 35 (0.8 - 4)	1500	2.0 (0.91)	8.35 212.0	0.8 - 1(20 - 26)	3/8" 	20V Li-ion	USB Only
QXC2PT08VS6	14 - 70 (1.6 - 8)	1150	2.0 (0.91)	8.35 212.0	0.8 - 1(20 - 26)	3/8" 	20V Li-ion	USB Only
QXC2PT08VQ4	14 - 70 (1.6 - 8)	1150	2.0 (0.91)	8.48 215.4	0.8 - 1(20 - 26)	1/4" 	20V Li-ion	USB Only
QXC2PT12VQ4	21 - 106 (2.4 - 12)	750	2.0 (0.91)	8.48 215.4	0.8 - 1(20 - 26)	1/4" 	20V Li-ion	USB Only
QXC2PT12VS6	21 - 106 (2.4 - 12)	750	2.0 (0.91)	8.35 212.0	0.8 - 1(20 - 26)	3/8" 	20V Li-ion	USB Only

# Cordless Precision Angle Wrench

## Angle



Model	 in-lbs (Nm)	 rpm	 lbs (kg)	 in (mm)	 in (mm)	 in	 V	 Communications
<b>DC TRIGGER START</b>								
QXX2AT05PQ4	9 - 44 (1.0 - 5)	1213	2.5 (1.14)	21.73 (552)	0.36 (9.2)	1/4" 	20V Li-ion	Wireless Enabled
QXX2AT10PS6	18 - 89 (2.0 - 10)	936	2.6 (1.18)	20.67 (525)	0.49 (12.5)	3/8" 	20V Li-ion	Wireless Enabled
QXX2AT15PS6	27 - 133 (3.0 - 15)	600	2.6 (1.18)	20.67 (525)	0.49 (12.5)	3/8" 	20V Li-ion	Wireless Enabled
QXX2AT18PQ4	32 - 159 (3.6 - 18)	500	2.8 (1.27)	24.34 (542)	0.51 (13)	1/4" 	20V Li-ion	Wireless Enabled
QXX2AT18PS6	32 - 159 (3.6 - 18)	500	2.8 (1.27)	24.34 (542)	0.51 (13)	3/8" 	20V Li-ion	Wireless Enabled
QXX2AT27PS6	48 - 239 (5.4 - 27)	330	3.7 (1.68)	21.73 (552)	0.67 (17)	3/8" 	20V Li-ion	Wireless Enabled
QXC2AT05PQ4	9 - 44 (1.0 - 5)	1213	2.5 (1.14)	21.73 (552)	0.36 (9.2)	1/4" 	20V Li-ion	USB Only
QXC2AT10PS6	18 - 89 (2.0 - 10)	936	2.6 (1.18)	20.67 (525)	0.49 (12.5)	3/8" 	20V Li-ion	USB Only
QXC2AT15PS6	27 - 133 (3.0 - 15)	600	2.6 (1.18)	20.67 (525)	0.49 (12.5)	3/8" 	20V Li-ion	USB Only
QXC2AT18PQ4	32 - 159 (3.6 - 18)	500	2.8 (1.27)	24.34 (542)	0.51 (13)	1/4" 	20V Li-ion	USB Only
QXC2AT18PS6	32 - 159 (3.6 - 18)	500	2.8 (1.27)	24.34 (542)	0.51 (13)	3/8" 	20V Li-ion	USB Only
QXC2AT27PS6	48 - 239 (5.4 - 27)	330	3.7 (1.68)	21.73 (552)	0.67 (17)	3/8" 	20V Li-ion	USB Only

# QX Series Process Communication Module (PCM)

<b>Power Cord</b>	BC10-CORD-US	IC-PCM-1-US	IC-PCM-2-US
<b>Tool Connections</b>	Wireless tool connections	10	1
<b>Software</b>	ICS Connect Software	•	•
<b>Power Supply</b>	120V AC input, 5V DC output	•	•
<b>Communication</b>	Ethernet to ICS	•	•
<b>Fieldbus Options</b>	Ethernet/IP, DeviceNet, Interbus-S, Profibus, Modbus-TCP		○
<b>Protocols</b>	Open Protocol, Ethernet EOR, Serial EOR		•
<b>Printers/Devices</b>	Serial RS232, bar code, label printing		•
<b>I/O</b>	8 inputs/8 outputs, with behavior assignable through ICS software, operates at 24V DC		•
<b>I/O Power Supply</b>	120V AC input, 24V DC output		•
<b>Indicators</b>	Power ON, System Ready, Wireless Activity, Ethernet Activity	•	•
<b>Ambient Operating Conditions</b>	0-50°C, 20/90% non-condensing humidity	•	•
<b>Enclosure</b>	IP52 mounted in upright vertical position	•	•
<b>System Weight</b>	3.0 lb (1.4 kg)	•	•
<b>Overall Dimensions</b>	11.5 in x 4.1 in x 8.3 in 291 mm x 103 mm x 210 mm	•	•

• = Standard ○ = Option



Process Communication Module  
IC-PCM-2-US



VP1 Boot Accessory

## Batteries

### IQ<sup>v20</sup> Series

Advanced Lithium-Ion Technology

All QX Series tools are compatible with both the BL2010 and BL2005 batteries. The BL2010 is optimum for longer use applications while the BL2005 is ideal for tighter spaces and reduced weight.

20V Battery Charger  
BC1120



1.5Ah Lithium-Ion  
Battery Pack  
BL2005

3.0Ah Lithium-Ion  
Battery Pack  
BL2010

# DC Electric Screwdriver

Inline

## QE2 Series Inline

The ultimate world-class combination - QE2 Series tools and IC Series controllers team to provide superior accuracy, ergonomics and durability to meet your critical fastening requirements. Full closed-loop transducerized control in a compact, lightweight package allows you to maximize your productivity.



QE2SL005P10Q04

### Features

- Torque Range: 2.7 - 88.5 in-lbs (0.3 - 10 Nm)
- Speeds: Adjustable to 3,000 rpm
- True closed-loop transducerized control provides exceptional accuracy
- Advanced tightening strategies
- Data and process communications
- TactAlert provides positive feedback to the operator without distracting from the task
- Bright LED headlights
- ESD Safe
- RoHS Compliant
- Super durable cable
- Compact, high-speed, easily accessible controls
- Easy-to-use reverse button
- Bright LEDs provide visible status indicators
- Comfortable ergonomic grip
- High-temperature motor protection
- Preventive maintenance alerts

### Service and Accessories

#### Manuals:

































- 45609799
- 16576951
- 16609703

#### Accessories:



- Torque Arms
- Cables
- Mounting Accessories
- Smart socket and bit trays
- Bio Brace
- Spring balancers

Spindle Accessories,  
Sockets, form # IRPS-0506-016  
IC12D & IC12M controller

Model	ft-lbs (Nm)	rpm	lbs (kg)	in (mm)	in (mm)	in
<b>DC QE2 INLINE PUSH-TO-START</b>						
QE2TS002P11Q04	2.7 - 13.3 (0.3 - 1.5)	3,000	1.25 (0.57)	9.84" (250)	0.86" (22)	1/4"
QE2TS002P11S04	2.7 - 13.3 (0.3 - 1.5)	3,000	1.25 (0.57)	9.53" (242)	0.86" (22)	1/4"
QE2TS003P11Q04	5.3 - 26.6 (0.6 - 3.0)	2,450	1.25 (0.57)	9.84" (250)	0.86" (22)	1/4"
QE2TS003P11S04	5.3 - 26.6 (0.6 - 3.0)	2,450	1.25 (0.57)	9.53" (242)	0.86" (22)	1/4"
QE2TS005P11Q04	8.9 - 44.3 (1.0 - 5.0)	1,700	1.25 (0.57)	9.84" (250)	0.86" (22)	1/4"
QE2TS005P11S04	8.9 - 44.3 (1.0 - 5.0)	1,700	1.25 (0.57)	9.53" (242)	0.86" (22)	1/4"
QE2TS007P11Q04	11.5 - 57.5 (1.3 - 6.5)	1,250	1.25 (0.57)	9.84" (250)	0.86" (22)	1/4"
QE2TS007P11S04	11.5 - 57.5 (1.3 - 6.5)	1,250	1.25 (0.57)	9.53" (242)	0.86" (22)	1/4"
QE2TS010P11Q04	17.7 - 88.5 (2.0 - 10.0)	850	1.25 (0.57)	9.84" (250)	0.86" (22)	1/4"
QE2TS010P11S04	17.7 - 88.5 (2.0 - 10.0)	850	1.25 (0.57)	9.53" (242)	0.86" (22)	1/4"

Model	 ft-lbs (Nm)	 rpm	 lbs (kg)	 in (mm)	 in (mm)	 in
<b>DC QE2 INLINE LEVER START</b>						
QE2SL002P10Q04	2.7 - 13.3 (0.3 - 1.5)	3,000	1.32 (0.60)	9.84" (250)	0.86" (22)	1/4" 
QE2SL002P10S04	2.7 - 13.3 (0.3 - 1.5)	3,000	1.32 (0.60)	9.53" (242)	0.86" (22)	1/4" 
QE2SL002F32S06	2.7 - 13.3 (0.3 - 1.5)	3,000	2.01 (0.91)	13.45" (342)	0.74" (19)	3/8" 
QE2SL003P10Q04	5.3 - 26.6 (0.6 - 3.0)	2,450	1.32 (0.60)	9.84" (250)	0.86" (22)	1/4" 
QE2SL003P10S04	5.3 - 26.6 (0.6 - 3.0)	2,450	1.32 (0.60)	9.53" (242)	0.86" (22)	1/4" 
QE2SL003F32S06	5.3 - 26.7 (0.6 - 3.0)	2,450	2.01 (0.91)	13.45" (342)	0.74" (19)	3/8" 
QE2SL005P10Q04	8.9 - 44.3 (1.0 - 5.0)	1,700	1.32 (0.60)	9.84" (250)	0.86" (22)	1/4" 
QE2SL005P10S04	8.9 - 44.3 (1.0 - 5.0)	1,700	1.32 (0.60)	9.53" (242)	0.86" (22)	1/4" 
QE2SL005F32S06	8.9 - 44.4 (1.0 - 5.0)	1,700	2.01 (0.91)	13.45" (342)	0.74" (19)	3/8" 
QE2SL007P10Q04	11.5 - 57.5 (1.3 - 6.5)	1,250	1.32 (0.60)	9.84" (250)	0.86" (22)	1/4" 
QE2SL007P10S04	11.5 - 57.5 (1.3 - 6.5)	1,250	1.32 (0.60)	9.53" (242)	0.86" (22)	1/4" 
QE2SL007F32S06	11.5 - 57.5 (1.3 - 6.5)	1,250	2.01 (0.91)	13.45" (342)	0.74" (19)	3/8" 
QE2SL010P10Q04	17.7 - 88.5 (2.0 - 10.0)	850	1.32 (0.60)	9.84" (250)	0.86" (22)	1/4" 
QE2SL010P10S04	17.7 - 88.5 (2.0 - 10.0)	850	1.32 (0.60)	9.53" (242)	0.86" (22)	1/4" 
QE2SL010F32S06	17.7 - 88.5 (2.0 - 10.0)	850	2.01 (0.91)	13.45" (342)	0.74" (19)	3/8" 
<b>DC QE2 INLINE LEVER + PUSH-TO-START</b>						
QE2SP002P11Q04	2.7 - 13.3 (0.3 - 1.5)	3,000	1.32 (0.60)	9.84" (250)	0.86" (22)	1/4" 
QE2SP002P11S04	2.7 - 13.3 (0.3 - 1.5)	3,000	1.32 (0.60)	9.53" (242)	0.86" (22)	1/4" 
QE2SP003P11Q04	5.3 - 26.6 (0.6 - 3.0)	2,450	1.32 (0.60)	9.84" (250)	0.86" (22)	1/4" 
QE2SP003P11S04	5.3 - 26.6 (0.6 - 3.0)	2,450	1.32 (0.60)	9.53" (242)	0.86" (22)	1/4" 
QE2SP005P11Q04	8.9 - 44.3 (1.0 - 5.0)	1,700	1.32 (0.60)	9.84" (250)	0.86" (22)	1/4" 
QE2SP005P11S04	8.9 - 44.3 (1.0 - 5.0)	1,700	1.32 (0.60)	9.53" (242)	0.86" (22)	1/4" 
QE2SP007P11Q04	11.5 - 57.5 (1.3 - 6.5)	1,250	1.32 (0.60)	9.84" (250)	0.86" (22)	1/4" 
QE2SP007P11S04	11.5 - 57.5 (1.3 - 6.5)	1,250	1.32 (0.60)	9.53" (242)	0.86" (22)	1/4" 
QE2SP010P11Q04	17.7 - 88.5 (2.0 - 10.0)	850	1.32 (0.60)	9.84" (250)	0.86" (22)	1/4" 
QE2SP010P11S04	17.7 - 88.5 (2.0 - 10.0)	850	1.32 (0.60)	9.53" (242)	0.86" (22)	1/4" 
<b>DC QE2 INLINE REMOTE START</b>						
QE2SC002F32S06	2.7 - 13.3 (0.3 - 1.5)	3,000	2.01 (0.91)	13.45" (342)	0.74" (18.66)	3/8" 
QE2SC003F32S06	5.3 - 26.6 (0.6 - 3.0)	2,450	2.01 (0.91)	13.45" (342)	0.74" (18.66)	3/8" 
QE2SC005F32S06	8.9 - 44.3 (1.0 - 5.0)	1,700	2.01 (0.91)	13.45" (342)	0.74" (18.66)	3/8" 
QE2SC007F32S06	11.5 - 57.5 (1.3 - 6.5)	1,250	2.01 (0.91)	13.45" (342)	0.74" (18.66)	3/8" 
QE2SC010F32S06	17.7 - 88.5 (2.0 - 10.0)	850	2.01 (0.91)	13.45" (342)	0.74" (18.66)	3/8" 

**Floating Spindle\***

	
in (mm)	in (mm)
.75" (19)	1.25" (31.7)



QE2SC007F32S06

# DC Electric Nutrunners

## Pistol Grip

### QE2 Series Pistol

The ultimate world-class combination - QE2 Series tools and IC Series controllers team to provide superior accuracy, ergonomics and durability to meet your critical fastening requirements. Full closed-loop transducerized control in a compact, lightweight package allows you to maximize your productivity.

#### Features

- Torque Range: 2.7 - 88.5 in-lbs (0.3 - 10 Nm)
- Speeds: Adjustable to 3,000 rpm
- True closed-loop transducerized control provides exceptional accuracy
- Advanced tightening strategies
- Data and process communications
- TactAlert provides positive feedback to the operator without distracting from the task
- Bright LED headlights
- RoHS Compliant
- Super durable cable
- Compact, high-speed, easily accessible controls
- Comfortable ergonomic grip
- High-temperature motor protection
- Preventive maintenance alerts
- Bright LEDs provide visible status indicators



QE2PT010P10Q04

#### Service and Accessories

##### Manuals:

- 45609799
- 16576951
- 16609703

##### Accessories:



























- Torque Arms
- Cables
- Mounting Accessories
- Smart socket and bit trays
- Bio Brace
- Spring balancers

- Spindle Accessories
- Sockets, form # IRPS-0506-016
- IC12D & IC12M controller

Model	in-lbs (Nm)	1 min. rpm	lbs (kg)	in (mm)	in (mm)	in
<b>DC QE2 PUSH-TO-START PISTOL</b>						
QE2PS002P11Q04	2.7 - 13.3 (0.3 - 1.5)	3,000	1.25 (0.57)	9.84" (250)	0.86" (22)	1/4"
QE2PS002P11S04	2.7 - 13.3 (0.3 - 1.5)	3,000	1.25 (0.57)	9.53" (242)	0.86" (22)	1/4"
QE2PS003P11Q04	5.3 - 26.6 (0.6 - 3.0)	2,450	1.25 (0.57)	9.84" (250)	0.86" (22)	1/4"
QE2PS003P11S04	5.3 - 26.6 (0.6 - 3.0)	2,450	1.25 (0.57)	9.53" (242)	0.86" (22)	1/4"
QE2PS005P11Q04	8.9 - 44.3 (1.0 - 5.0)	1,700	1.25 (0.57)	9.84" (250)	0.86" (22)	1/4"
QE2PS005P11S04	8.9 - 44.3 (1.0 - 5.0)	1,700	1.25 (0.57)	9.53" (242)	0.86" (22)	1/4"
QE2PS007P11Q04	11.5 - 57.5 (1.3 - 6.5)	1,250	1.25 (0.57)	9.84" (250)	0.86" (22)	1/4"
QE2PS007P11S04	11.5 - 57.5 (1.3 - 6.5)	1,250	1.25 (0.57)	9.53" (242)	0.86" (22)	1/4"
QE2PS010P11Q04	17.7 - 88.5 (2.0 - 10.0)	850	1.25 (0.57)	9.84" (250)	0.86" (22)	1/4"
QE2PS010P11S04	17.7 - 88.5 (2.0 - 10.0)	850	1.25 (0.57)	9.53" (242)	0.86" (22)	1/4"

# DC Electric Nutrunners

## Pistol Grip

Model	 in-lbs (Nm)	 rpm	 lbs (kg)	 in (mm)	 in (mm)	 in
<b>DC QE2 TRIGGER START PISTOL</b>						
QE2PT002P10Q04	2.7 - 13.3 (0.3 - 1.5)	3,000	1.46 (0.66)	9.84" (250)	0.76" (19)	1/4" 
QE2PT002P10S04	2.7 - 13.3 (0.3 - 1.5)	3,000	1.46 (0.66)	9.53" (242)	0.76" (19)	1/4" 
QE2PT003P10Q04	5.3 - 26.6 (0.6 - 3.0)	2,450	1.46 (0.66)	9.84" (250)	0.76" (19)	1/4" 
QE2PT003P10S04	5.3 - 26.6 (0.6 - 3.0)	2,450	1.46 (0.66)	9.53" (242)	0.76" (19)	1/4" 
QE2PT003P10S04	8.9 - 44.3 (1.0 - 5.0)	1,700	1.46 (0.66)	9.84" (250)	0.76" (19)	1/4" 
QE2PT005P10S04	8.9 - 44.3 (1.0 - 5.0)	1,700	1.46 (0.66)	9.53" (242)	0.76" (19)	1/4" 
QE2PT007P10Q04	11.5 - 57.5 (1.3 - 6.5)	1,250	1.46 (0.66)	9.84" (250)	0.76" (19)	1/4" 
QE2PT007P10S04	11.5 - 57.5 (1.3 - 6.5)	1,250	1.46 (0.66)	9.53" (242)	0.76" (19)	1/4" 
QE2PT010P10Q04	17.7 - 88.5 (2.0 - 10.0)	850	1.46 (0.66)	9.84" (250)	0.76" (19)	1/4" 
QE2PT010P10S04	17.7 - 88.5 (2.0 - 10.0)	850	1.46 (0.66)	9.53" (242)	0.76" (19)	1/4" 
<b>DC QE2 TRIGGER + PUSH-TO-START PISTOL</b>						
QE2PP002P11Q04	2.7 - 13.3 (0.3 - 1.5)	3,000	1.46 (0.66)	9.84" (250)	0.76" (19)	1/4" 
QE2PP002P11S04	2.7 - 13.3 (0.3 - 1.5)	3,000	1.46 (0.66)	9.53" (242)	0.76" (19)	1/4" 
QE2PP003P11Q04	5.3 - 26.6 (0.6 - 3.0)	2,450	1.46 (0.66)	9.84" (250)	0.76" (19)	1/4" 
QE2PP003P11S04	5.3 - 26.6 (0.6 - 3.0)	2,450	1.46 (0.66)	9.53" (242)	0.76" (19)	1/4" 
QE2PP005P11Q04	8.9 - 44.3 (1.0 - 5.0)	1,700	1.46 (0.66)	9.84" (250)	0.76" (19)	1/4" 
QE2PP005P11S04	8.9 - 44.3 (1.0 - 5.0)	1,700	1.46 (0.66)	9.53" (242)	0.76" (19)	1/4" 
QE2PP007P11Q04	11.5 - 57.5 (1.3 - 6.5)	1,250	1.46 (0.66)	9.84" (250)	0.76" (19)	1/4" 
QE2PP007P11S04	11.5 - 57.5 (1.3 - 6.5)	1,250	1.46 (0.66)	9.53" (242)	0.76" (19)	1/4" 
QE2PP010P11Q04	17.7 - 88.5 (2.0 - 10.0)	850	1.46 (0.66)	9.84" (250)	0.76" (19)	1/4" 
QE2PP010P11S04	17.7 - 88.5 (2.0 - 10.0)	850	1.46 (0.66)	9.53" (242)	0.76" (19)	1/4" 



CPS2-CORD-3M (3 meter)  
 CPS2-CORD-6M (6 meter)  
 CPS2-CORD-10M (10 meter)  
 CPS2-CORD-6M-90 (90 degree, 6 meter)



# DC Electric Nutrunners

## Angle

### QE2 Series Angles

The ultimate world-class combination - QE2 Series tools and IC Series controllers team to provide superior accuracy, ergonomics and durability to meet your critical fastening requirements. Full closed-loop transducerized control in a compact, lightweight package allows you to maximize your productivity.



QE2AL003PA1S04

#### Features

- Torque Range: 7- 132 in-lbs (0.8 - 15 Nm)
- Speeds: Adjustable to 1,750 rpm
- True closed-loop transducerized control provides exceptional accuracy
- Advanced tightening strategies
- Data and process communications
- TactAlert provides positive feedback to the operator without distracting from the task
- ESD Safe
- RoHS Compliant
- Super durable cable
- Compact, high-speed, easily accessible controls
- Easy-to-use reverse button
- Bright LEDs provide visible status indicators
- Comfortable ergonomic grip
- High-temperature motor protection
- Preventive maintenance alerts

#### Service and Accessories

##### Manuals:

- 45609799
- 16576951
- 16609703

##### Accessories:

- Torque Arms
- Cables
- Mounting Accessories
- Smart socket and bit trays
- Bio Brace
- Spring balancers















##### Spindle Accessories

- Sockets, form # IRPS-0506-016
- IC12D & IC12M controller

Model	in-lbs (Nm)	rpm	lbs (kg)	in (mm)	in (mm)	in
<b>DC QE2 ANGLE LEVER START</b>						
QE2AL003PA1S04	7 - 35 (0.8 - 4)	1,750	1.82 (0.83)	12.29" (312)	0.37" (9)	1/4"
QE2AL005PA3S04	9 - 44 (1 - 5)	1,590	2.10 (0.95)	12.53" (318)	0.51" (13)	1/4"
QE2AL005PA3S06	9 - 44 (1 - 5)	1,590	2.10 (0.95)	12.53" (318)	0.51" (13)	3/8"
QE2AL005PA3Q04	9 - 44 (1 - 5)	1,590	2.10 (0.95)	12.53" (318)	0.51" (13)	1/4"
QE2AL005PA3H04	9 - 44 (1 - 5)	1,590	2.10 (0.95)	12.53" (318)	0.51" (13)	1/4"
QE2AL007PA3S06	12 - 62 (1.4 - 7)	1,100	2.10 (0.95)	12.53" (318)	0.51" (13)	3/8"
QE2AL007PA3Q04	12 - 62 (1.4 - 7)	1,100	2.10 (0.95)	12.53" (318)	0.51" (13)	1/4"
QE2AL007PA3H04	12 - 62 (1.4 - 7)	1,100	2.10 (0.95)	12.53" (318)	0.51" (13)	1/4"

# DC Electric Nutrunners

## Angle

						
Model	in-lbs (Nm)	rpm	lbs (kg)	in (mm)	in (mm)	in
<b>DC QE2 ANGLE LEVER START</b>						
QE2AL010PA3S04	18 - 88 (2 - 10)	730	2.10 (0.95)	12.29" (312)	0.51" (13)	1/4" 
QE2AL010PA3S06	18 - 88 (2 - 10)	730	2.10 (0.95)	12.53" (318)	0.51" (13)	3/8" 
QE2AL010PA3Q04	18 - 88 (2 - 10)	730	2.10 (0.95)	12.53" (318)	0.51" (13)	1/4" 
QE2AL010PA3H04	18 - 88 (2 - 10)	730	2.10 (0.95)	12.53" (318)	0.51" (13)	1/4" 
QE2AL015PA3S04	26 - 132 (3 - 15)	560	2.10 (0.95)	12.53" (318)	0.51" (13)	1/4" 
QE2AL015PA3S06	26 - 132 (3 - 15)	560	2.10 (0.95)	12.53" (318)	0.51" (13)	3/8" 
QE2AL015PA3Q04	26 - 132 (3 - 15)	560	2.10 (0.95)	12.53" (318)	0.51" (13)	1/4" 
QE2AL015PA3H04	26 - 132 (3 - 15)	560	2.10 (0.95)	12.53" (318)	0.51" (13)	1/4" 

# DC Electric Nutrunners

## Motors

### QE2 Series Motors

QE2 Series Motors offer off-the-shelf flexibility to customize tools based on your specific needs. Tube nut and screw feeder attachments are just some of the end effectors that can be attached to the world-class QE2 Series to meet your critical fastening requirements and to maximize your productivity.

#### Features

- Torque Range: 2.7 - 88.5 in-lbs (0.3 - 10 Nm)
- Speeds: Adjustable to 3,000 rpm
- True closed-loop transducerized control provides exceptional accuracy
- Advanced tightening strategies
- Data and process communications
- TactAlert provides positive feedback to the operator without distracting from the task
- ESD Safe
- RoHS Compliant
- Super durable cable
- Compact, high-speed, easily accessible controls
- Easy-to-use reverse button
- Bright LEDs provide visible status indicators
- Comfortable ergonomic grip
- High-temperature motor protection
- Preventive maintenance alerts

#### Service and Accessories

##### Manuals:

-  45609799
-  16576951
-  16609703

##### Accessories:

- Torque Arms
- Cables
- Mounting Accessories
- Smart socket and bit trays
- Bio Brace
- Spring balancers





- Spindle Accessories
- Sockets, form # IRPS-0506-016
- IC12D & IC12M controller



QE2PT005PM0













QE2SL003PM0

Model	 in-lbs (Nm)	 rpm	 lbs (kg)	 in (mm)	 in (mm)
<b>DC QE2 PUSH-TO-START INLINE MOTOR</b>					
QE2TS002PM0	2.7 - 13.3 (0.3 - 1.5)	3,000	1.52 (0.67)	9.81" (250)	0.86" (22)
QE2TS003PM0	5.3 - 26.6 (0.6 - 3.0)	2,400	1.52 (0.67)	9.81" (250)	0.86" (22)
QE2TS005PM0	8.9 - 44.3 (1.0 - 5.0)	1,700	1.52 (0.67)	9.81" (250)	0.86" (22)
QE2TS007PM0	11.5 - 57.5 (1.3 - 6.5)	1,250	1.52 (0.67)	9.81" (250)	0.86" (22)
QE2TS010PM0	17.7 - 88.5 (2.0 - 10.0)	850	1.52 (0.67)	9.81" (250)	0.86" (22)
<b>DC QE2 LEVER START INLINE MOTOR</b>					
QE2SL002PM0	2.7 - 13.3 (0.3 - 1.5)	3,000	1.52 (0.67)	9.81" (250)	0.86" (22)
QE2SL003PM0	5.3 - 26.6 (0.6 - 3.0)	2,400	1.52 (0.67)	9.81" (250)	0.86" (22)
QE2SL005PM0	8.9 - 44.3 (1.0 - 5.0)	1,700	1.52 (0.67)	9.81" (250)	0.86" (22)
QE2SL007PM0	11.5 - 57.5 (1.3 - 6.5)	1,250	1.52 (0.67)	9.81" (250)	0.86" (22)
QE2SL010PM0	17.7 - 88.5 (2.0 - 10.0)	850	1.52 (0.67)	9.81" (250)	0.86" (22)

# DC Electric Nutrunners

## Motors

Model	 in-lbs (Nm)	 rpm	 lbs (kg)	 in (mm)	 in (mm)
<b>DC QE2 PUSH-TO-START INLINE MOTOR</b>					
QE2SP002PM0	2.7 - 13.3 (0.3 - 1.5)	3,000	1.52 (0.67)	9.81" (250)	0.86" (22)
QE2SP003PM0	5.3 - 26.6 (0.6 - 3.0)	2,400	1.52 (0.67)	9.81" (250)	0.86" (22)
QE2SP005PM0	8.9 - 44.3 (1.0 - 5.0)	1,700	1.52 (0.67)	9.81" (250)	0.86" (22)
QE2SP007PM0	11.5 - 57.5 (1.3 - 6.5)	1,250	1.52 (0.67)	9.81" (250)	0.86" (22)
QE2SP010PM0	17.7 - 88.5 (2.0 - 10.0)	850	1.52 (0.67)	9.81" (250)	0.86" (22)

Model	 In-lbs (Nm)	 rpm	 lbs (kg)	 in (mm)	 in (mm)
<b>DC QE2 PUSH-TO-START INLINE MOTOR</b>					
QE2PS002PM0	2.7 - 13.3 (0.3 - 1.5)	3,000	1.60 (0.72)	9.81" (250)	0.76" (19)
QE2PS003PM0	5.3 - 26.6 (0.6 - 3.0)	2,400	1.60 (0.72)	9.81" (250)	0.76" (19)
QE2PS005PM0	8.9 - 44.3 (1.0 - 5.0)	1,700	1.60 (0.72)	9.81" (250)	0.76" (19)
QE2PS007PM0	11.5 - 57.5 (1.3 - 6.5)	1,250	1.60 (0.72)	9.81" (250)	0.76" (19)
QE2PS010PM0	17.7 - 88.5 (2.0 - 10.0)	850	1.60 (0.72)	9.81" (250)	0.76" (19)
<b>DC QE2 TRIGGER START PISTOL MOTOR</b>					
QE2PT002PM0	2.7 - 13.3 (0.3 - 1.5)	3,000	1.60 (0.72)	9.81" (250)	0.76" (19)
QE2PT003PM0	5.3 - 26.6 (0.6 - 3.0)	2,400	1.60 (0.72)	9.81" (250)	0.76" (19)
QE2PT005PM0	8.9 - 44.3 (1.0 - 5.0)	1,700	1.60 (0.72)	9.81" (250)	0.76" (19)
QE2PT007PM0	11.5 - 57.5 (1.3 - 6.5)	1,250	1.60 (0.72)	9.81" (250)	0.76" (19)
QE2PT010PM0	17.7 - 88.5 (2.0 - 10.0)	850	1.60 (0.72)	9.81" (250)	0.76" (19)
<b>DC QE2 TRIGGER + PUSH-TO-START PISTOL MOTOR</b>					
QE2PP002PM0	2.7 - 13.3 (0.3 - 1.5)	3,000	1.60 (0.72)	9.81" (250)	0.76" (19)
QE2PP003PM0	5.3 - 26.6 (0.6 - 3.0)	2,400	1.60 (0.72)	9.81" (250)	0.76" (19)
QE2PP005PM0	8.9 - 44.3 (1.0 - 5.0)	1,700	1.60 (0.72)	9.81" (250)	0.76" (19)
QE2PP007PM0	11.5 - 57.5 (1.3 - 6.5)	1,250	1.60 (0.72)	9.81" (250)	0.76" (19)
QE2PP010PM0	17.7 - 88.5 (2.0 - 10.0)	850	1.60 (0.72)	9.81" (250)	0.76" (19)

# DC Electric Nutrunners

## Push-to-Start

### QE4 Push-to-Start Inline

Offering accurate, high-speed, one-handed operation, this tool is activated when the operator presses down on the fastener. This eliminates the need for a lever, saving time and effort. The tool's unique clevis attachment allows for easy attachment to torque arms while offering the operator optimal hand positioning and workpiece visibility.



QE4TS010R11Q04

#### Features

- Torque Range: 0.75 – 18.3 ft-lbs (1 – 25 Nm)
- Speeds: Adjustable to 1820 rpm
- True closed-loop transducerized control provides exceptional accuracy
- Advanced tightening strategies and data and process communications
- Compact, high-speed, easily accessible controls
- Non-contacting switches, heavy-duty gear train, and DC brushless motor provide exceptional durability
- TactAlert provides positive feedback to the operator without distracting from the task
- Preventive maintenance alerts
- Comfortable ergonomic grip
- High-temperature motor protection
- Easy-to-use reverse ring
- Bright LEDs provide visible status indicators

#### Service and Accessories

##### Manuals:

- 16574451
- 19576951
- 16575151

##### Accessories:

- Reaction bar kit: GEPTS15-K48
- Torque arms
- Cable
- IC12D & IC12M controller

Model	ft-lbs (Nm)	rpm	lbs (kg)	in (mm)	in (mm)	in
<b>DC INLINE PUSH-TO-START</b>						
QE4TS010R11Q04	0.75 – 7.4 (1 – 10)	1,820	2.6 (1.2)	14.2" (363)	0.98" (25)	1/4"
QE4TS010R11S04	0.75 – 7.4 (1 – 10)	1,820	2.6 (1.2)	13.4" (343)	0.98" (25)	1/4"
QE4TS010R11S06	0.75 – 7.4 (1 – 10)	1,820	2.6 (1.2)	13.4" (343)	0.98" (25)	3/8"
QE4TS015R11Q04	1.1 – 11.0 (1.5 – 15)	1,220	2.6 (1.2)	14.2" (363)	0.98" (25)	1/4"
QE4TS015R11S04	1.1 – 11.0 (1.5 – 15)	1,220	2.6 (1.2)	13.4" (343)	0.98" (25)	1/4"
QE4TS015R11S06	1.1 – 11.0 (1.5 – 15)	1,220	2.6 (1.2)	13.4" (343)	0.98" (25)	3/8"
QE4TS020R11S06	1.5 – 14.7 (2 – 20)	900	2.6 (1.2)	13.4" (343)	0.98" (25)	3/8"
QE4TS025R11S06	1.8 – 18.3 (2.5 – 25)	710	2.6 (1.2)	13.4" (343)	0.98" (25)	3/8"

# DC Electric Nutrunners

## Pistol Grip

### QE4 Pistol

Provides the utility of a pistol tool while delivering the accuracy of a closed-loop transducerized DC system. With three modes of activation, bright LED headlight, and a standard reaction bar, this tool meets all the requirements of the most demanding jobs when teamed with an IC controller.



QE4PT015P10S04

#### Features

- Torque Range: 0.75 – 18.3 ft-lbs (1 – 25 Nm)
- Speeds: Adjustable to 1820 rpm
- True closed-loop transducerized control provides exceptional accuracy
- Advanced tightening strategies and data and process communications
- Non-contacting switches, heavy-duty gear train, and DC brushless motor provide exceptional durability
- Bright LED headlight
- Compact, high-speed, easily accessible controls
- Comfortable ergonomic grip
- Preventive maintenance alerts
- High-temperature motor protection
- Bright LEDs provide visible status indicators
- TactAlert provides positive feedback to the operator without distracting from the task
- Reaction bar standard

#### Service and Accessories

##### Manuals:

- 80151632
- 80151590
- 80151624























##### Accessories:

- Reaction bar kit: GEPTS15-K48
- Torque arms
- Cable
- IC12D & IC12M controller

Model	ft-lbs (Nm)	1 min. rpm	lbs (kg)	in (mm)	in (mm)	in
<b>DC TRIGGER + PUSH-TO-START</b>						
QE4PP010P11Q04	0.75 – 7.4 (1 – 10)	1,820	2.9 (1.3)	9.5" (243)	0.8" (20.3)	1/4"
QE4PP010P11S04	0.75 – 7.4 (1 – 10)	1,820	2.9 (1.3)	9.0" (230)	0.8" (20.3)	1/4"
QE4PP010P11S06	0.75 – 7.4 (1 – 10)	1,820	2.9 (1.3)	9.1" (234)	0.8" (20.3)	3/8"
QE4PP015P11Q04	1.1 – 11.0 (1.5 – 15)	1,220	2.9 (1.3)	9.5" (243)	0.8" (20.3)	1/4"
QE4PP015P11S04	1.1 – 11.0 (1.5 – 15)	1,220	2.9 (1.3)	9.0" (230)	0.8" (20.3)	1/4"
QE4PP015P11S06	1.1 – 11.0 (1.5 – 15)	1,220	2.9 (1.3)	9.1" (234)	0.8" (20.3)	3/8"
QE4PP020P11S06	1.5 – 14.7 (2 – 20)	900	2.9 (1.3)	9.1" (234)	0.8" (20.3)	3/8"
QE4PP025P11S06	1.8 – 18.3 (2.5 – 25)	710	2.9 (1.3)	9.1" (234)	0.8" (20.3)	3/8"

# DC Electric Nutrunners

## Pistol Grip

Model	 ft-lbs (Nm)	 rpm	 lbs (kg)	 in (mm)	 in (mm)	 in
<b>DC PUSH-TO-START</b>						
QE4PS010P11Q04	0.75 – 7.4 (1 – 10)	1,820	2.9 (1.3)	9.5" (243)	0.8" (20.3)	1/4" 
QE4PS010P11S04	0.75 – 7.4 (1 – 10)	1,820	2.9 (1.3)	9.0" (230)	0.8" (20.3)	1/4" 
QE4PS010P11S06	0.75 – 7.4 (1 – 10)	1,820	2.9 (1.3)	9.1" (234)	0.8" (20.3)	3/8" 
QE4PS015P11Q04	1.1 – 11.0 (1.5 – 15)	1,220	2.9 (1.3)	9.5" (243)	0.8" (20.3)	1/4" 
QE4PS015P11S04	1.1 – 11.0 (1.5 – 15)	1,220	2.9 (1.3)	9.0" (230)	0.8" (20.3)	1/4" 
QE4PS015P11S06	1.1 – 11.0 (1.5 – 15)	1,220	2.9 (1.3)	9.1" (234)	0.8" (20.3)	3/8" 
QE4PS020P11S06	1.5 – 14.7 (2 – 20)	900	2.9 (1.3)	9.1" (234)	0.8" (20.3)	3/8" 
QE4PS025P11S06	1.8 – 18.3 (2.5 – 25)	710	2.9 (1.3)	9.1" (234)	0.8" (20.3)	3/8" 
<b>DC TRIGGER START</b>						
QE4PT010P10Q04	0.75 – 7.4 (1 – 10)	1,820	2.9 (1.3)	9.5" (243)	0.8" (20.3)	1/4" 
QE4PT010P10S04	0.75 – 7.4 (1 – 10)	1,820	2.9 (1.3)	9.0" (230)	0.8" (20.3)	1/4" 
QE4PT010P10S06	0.75 – 7.4 (1 – 10)	1,820	2.9 (1.3)	9.1" (234)	0.8" (20.3)	3/8" 
QE4PT015P10Q04	1.1 – 11.0 (1.5 – 15)	1,220	2.9 (1.3)	9.5" (243)	0.8" (20.3)	1/4" 
QE4PT015P10S04	1.1 – 11.0 (1.5 – 15)	1,220	2.9 (1.3)	9.0" (230)	0.8" (20.3)	1/4" 
QE4PT015P10S06	1.1 – 11.0 (1.5 – 15)	1,220	2.9 (1.3)	9.1" (234)	0.8" (20.3)	3/8" 
QE4PT020P10S06	1.5 – 14.7 (2 – 20)	900	2.9 (1.3)	9.1" (234)	0.8" (20.3)	3/8" 
QE4PT025P10S06	1.8 – 18.3 (2.5 – 25)	710	2.9 (1.3)	9.1" (234)	0.8" (20.3)	3/8" 

# DC Electric Nutrunners

Inline

## QE Series Inlines

A proven world-class combination — QE tools and IC Series controllers team up to provide superior accuracy and durability and meet your critical fastening requirements. The non-contacting switches, heavy-duty gear train, and DC brushless motor create a durable package while the compact, ergonomic design and easily accessible controls help operators keep production lines running smoothly.



QE4ST010B21Q04

### Features

- Torque Range: 0.75 – 169 ft-lbs (1.0 – 230 Nm)
- Speeds: Adjustable to 1,840 rpm
- True closed-loop transducerized control provides exceptional accuracy
- Advanced tightening strategies and data and process communications
- TactAlert provides positive feedback to the operator without distracting from the task
- Compact, high-speed, easily accessible controls
- Bright LEDs provide visible status indicators
- Comfortable ergonomic grip
- High-temperature motor protection
- Preventive maintenance alerts

### Service and Accessories

#### Factory-Direct Options for QE4, QE6 and QE8

Activation: Fifth Digit QE8S( )

T = Trigger

L = Lever

E = Extended Lever

C = Machine Start

Mounting: Ninth Digit QE8ST230( )

P = No Mount

F = Flanged Mount

R = Reaction Bar Mount

B = Flange Mount Kit

J = Two-Piece Mounting Plate

#### Accessories:

- Torque arms
- Cables
- Smart socket trays
- Mounting flanges
- Extended lever
- IC12D & C12M controllers
- Hanger accessories
- Spindle accessories

#### Manuals:

Spindle Length: Tenth Digit QE8ST230F( )



16574451



16576951







































16575151

Model	ft-lbs (Nm)	rpm	lbs (kg)	in (mm)	in (mm)	in	in (mm)
<b>DC QE4 INLINE</b>							
QE4ST010B20Q04	0.75 – 7.4 (1 – 10)	1,820	2.65 (1.2)	16" (406)	0.95" (24.25)	1/4"	0" (0)
QE4ST010B20S04	0.75 – 7.4 (1 – 10)	1,820	2.65 (1.2)	16" (406)	0.95" (24.25)	1/4"	0" (0)
QE4ST010B20S06	0.75 – 7.4 (1 – 10)	1,820	2.65 (1.2)	16" (406)	0.95" (24.25)	3/8"	0" (0)
QE4ST010B21Q04	0.75 – 7.4 (1 – 10)	1,820	2.65 (1.2)	16" (406)	0.95" (24.25)	1/4"	1.50" (38)
QE4ST010B21S04	0.75 – 7.4 (1 – 10)	1,820	2.65 (1.2)	16" (406)	0.95" (24.25)	1/4"	1.50" (38)
QE4ST010B21S06	0.75 – 7.4 (1 – 10)	1,820	2.65 (1.2)	16" (406)	0.95" (24.25)	3/8"	1.50" (38)
QE4ST010B21S08	0.75 – 7.4 (1 – 10)	1,820	2.65 (1.2)	16" (406)	0.95" (24.25)	1/2"	1.50" (38)
QE4ST010B41Q04	0.75 – 7.4 (1 – 10)	1,820	2.87 (1.3)	18" (457)	0.95" (24.25)	1/4"	1.50" (38)
QE4ST010B41S04	0.75 – 7.4 (1 – 10)	1,820	2.87 (1.3)	18" (457)	0.95" (24.25)	1/4"	1.50" (38)
QE4ST010B41S06	0.75 – 7.4 (1 – 10)	1,820	2.87 (1.3)	18" (457)	0.95" (24.25)	3/8"	1.50" (38)
QE4ST010B41S08	0.75 – 7.4 (1 – 10)	1,820	2.87 (1.3)	18" (457)	0.95" (24.25)	1/2"	1.50" (38)
QE4ST015B20Q04	1.1 – 11.0 (1.5 – 15)	1,220	2.65 (1.2)	16" (406)	0.95" (24.25)	1/4"	0" (0)
QE4ST015B20S04	1.1 – 11.0 (1.5 – 15)	1,220	2.65 (1.2)	16" (406)	0.95" (24.25)	1/4"	0" (0)
QE4ST015B20S06	1.1 – 11.0 (1.5 – 15)	1,220	2.65 (1.2)	16" (406)	0.95" (24.25)	3/8"	0" (0)



# DC Electric Nutrunners

## Inline

Model	 ft-lbs (Nm)	 rpm	 lbs (kg)	 in (mm)	 in (mm)	 in	 in (mm)
<b>DC</b> QE4 INLINE (CONTINUED)							
QE4ST015B21Q04	1.1 – 11.0 (1.5 – 15)	1,220	2.65 (1.2)	16" (406)	0.95" (24.25)	1/4" 	1.50" (38)
QE4ST015B21S04	1.1 – 11.0 (1.5 – 15)	1,220	2.65 (1.2)	16" (406)	0.95" (24.25)	1/4" 	1.50" (38)
QE4ST015B21S06	1.1 – 11.0 (1.5 – 15)	1,220	2.65 (1.2)	16" (406)	0.95" (24.25)	3/8" 	1.50" (38)
QE4ST015B21S08	1.1 – 11.0 (1.5 – 15)	1,220	2.65 (1.2)	16" (406)	0.95" (24.25)	1/2" 	1.50" (38)
QE4ST015B41Q04	1.1 – 11.0 (1.5 – 15)	1,220	2.87 (1.3)	16" (406)	0.95" (24.25)	1/4" 	1.50" (38)
QE4ST015B41S04	1.1 – 11.0 (1.5 – 15)	1,220	2.87 (1.3)	16" (406)	0.95" (24.25)	1/4" 	1.50" (38)
QE4ST015B41S06	1.1 – 11.0 (1.5 – 15)	1,220	2.87 (1.3)	16" (406)	0.95" (24.25)	3/8" 	1.50" (38)
QE4ST015B41S08	1.1 – 11.0 (1.5 – 15)	1,220	2.87 (1.3)	16" (406)	0.95" (24.25)	1/2" 	1.50" (38)
QE4ST020B20Q04	1.5 – 14.7 (2 – 20)	900	2.65 (1.2)	16" (406)	0.95" (24.25)	1/4" 	0" (0)
QE4ST020B20S04	1.5 – 14.7 (2 – 20)	900	2.65 (1.2)	16" (406)	0.95" (24.25)	1/4" 	0" (0)
QE4ST020B20S06	1.5 – 14.7 (2 – 20)	900	2.65 (1.2)	16" (406)	0.95" (24.25)	3/8" 	0" (0)
QE4ST020B21Q04	1.5 – 14.7 (2 – 20)	900	2.65 (1.2)	16" (406)	0.95" (24.25)	1/4" 	1.50" (38)
QE4ST020B21S04	1.5 – 14.7 (2 – 20)	900	2.65 (1.2)	16" (406)	0.95" (24.25)	1/4" 	1.50" (38)
QE4ST020B21S06	1.5 – 14.7 (2 – 20)	900	2.65 (1.2)	16" (406)	0.95" (24.25)	3/8" 	1.50" (38)
QE4ST020B21S08	1.5 – 14.7 (2 – 20)	900	2.65 (1.2)	16" (406)	0.95" (24.25)	1/2" 	1.50" (38)
QE4ST020B41Q04	1.5 – 14.7 (2 – 20)	900	2.87 (1.3)	18" (457)	0.95" (24.25)	1/4" 	1.50" (38)
QE4ST020B41S04	1.5 – 14.7 (2 – 20)	900	2.87 (1.3)	18" (457)	0.95" (24.25)	1/4" 	1.50" (38)
QE4ST020B41S06	1.5 – 14.7 (2 – 20)	900	2.87 (1.3)	18" (457)	0.95" (24.25)	3/8" 	1.50" (38)
QE4ST020B41S08	1.5 – 14.7 (2 – 20)	900	2.87 (1.3)	18" (457)	0.95" (24.25)	1/2" 	1.50" (38)
QE4ST025B20Q04	1.8 – 18.3 (2.5 – 25)	710	2.65 (1.2)	16" (406)	0.95" (24.25)	1/4" 	0" (0)
QE4ST025B20S04	1.8 – 18.3 (2.5 – 25)	710	2.65 (1.2)	16" (406)	0.95" (24.25)	1/4" 	0" (0)
QE4ST025B20S06	1.8 – 18.3 (2.5 – 25)	710	2.65 (1.2)	16" (406)	0.95" (24.25)	3/8" 	0" (0)
QE4ST025B21Q04	1.8 – 18.3 (2.5 – 25)	710	2.65 (1.2)	16" (406)	0.95" (24.25)	1/4" 	1.50" (38)
QE4ST025B21S04	1.8 – 18.3 (2.5 – 25)	710	2.65 (1.2)	16" (406)	0.95" (24.25)	1/4" 	1.50" (38)
QE4ST025B21S06	1.8 – 18.3 (2.5 – 25)	710	2.65 (1.2)	16" (406)	0.95" (24.25)	3/8" 	1.50" (38)
QE4ST025B21S08	1.8 – 18.3 (2.5 – 25)	710	2.65 (1.2)	16" (406)	0.95" (24.25)	1/2" 	1.50" (38)
QE4ST025B41Q04	1.8 – 18.3 (2.5 – 25)	710	2.87 (1.3)	18" (457)	0.95" (24.25)	1/4" 	1.50" (38)
QE4ST025B41S04	1.8 – 18.3 (2.5 – 25)	710	2.87 (1.3)	18" (457)	0.95" (24.25)	1/4" 	1.50" (38)
QE4ST025B41S06	1.8 – 18.3 (2.5 – 25)	710	2.87 (1.3)	18" (457)	0.95" (24.25)	3/8" 	1.50" (38)
QE4ST025B41S08	1.8 – 18.3 (2.5 – 25)	710	2.87 (1.3)	18" (457)	0.95" (24.25)	1/2" 	1.50" (38)

# DC Electric Nutrunners





























## Inline

### Manuals:

 16574469

 16576951

 16575169

Model	 ft-lbs (Nm)	 rpm	 lbs (kg)	 in (mm)	 in (mm)	 in	 in (mm)
<b>DC QE6 INLINE</b>							
QE6ST020F41S06	1.5 – 14.7 (2 – 20)	1,840	4.63 (2.1)	19.72" (501)	1.08" (27.35)	3/8" 	1.50" (38)
QE6ST020F41S08	1.5 – 14.7 (2 – 20)	1,840	4.63 (2.1)	19.72" (501)	1.08" (27.35)	1/2" 	1.50" (38)
QE6ST020F61S06	1.5 – 14.7 (2 – 20)	1,840	4.85 (2.2)	21.42" (544)	1.08" (27.35)	3/8" 	1.50" (38)
QE6ST020F61S08	1.5 – 14.7 (2 – 20)	1,840	4.85 (2.2)	21.42" (544)	1.08" (27.35)	1/2" 	1.50" (38)
QE6ST020F81S06	1.5 – 14.7 (2 – 20)	1,840	5.07 (2.3)	23.39" (594)	1.08" (27.35)	3/8" 	1.50" (38)
QE6ST020F81S08	1.5 – 14.7 (2 – 20)	1,840	5.07 (2.3)	23.39" (594)	1.08" (27.35)	1/2" 	1.50" (38)
QE6ST028F41S06	2.0 – 20 (2.8 – 28)	1,360	4.63 (2.1)	19.72" (501)	1.08" (27.35)	3/8" 	1.50" (38)
QE6ST028F41S08	2.0 – 20 (2.8 – 28)	1,360	4.63 (2.1)	19.72" (501)	1.08" (27.35)	1/2" 	1.50" (38)
QE6ST028F61S06	2.0 – 20 (2.8 – 28)	1,360	4.85 (2.2)	21.42" (544)	1.08" (27.35)	3/8" 	1.50" (38)
QE6ST028F61S08	2.0 – 20 (2.8 – 28)	1,360	4.85 (2.2)	21.42" (544)	1.08" (27.35)	1/2" 	1.50" (38)
QE6ST028F81S06	2.0 – 20 (2.8 – 28)	1,360	5.07 (2.3)	23.39" (594)	1.08" (27.35)	3/8" 	1.50" (38)
QE6ST028F81S08	2.0 – 20 (2.8 – 28)	1,360	5.07 (2.3)	23.39" (594)	1.08" (27.35)	1/2" 	1.50" (38)
QE6ST033F41S06	2.4 – 24 (3.3 – 33)	1,130	4.63 (2.1)	19.72" (501)	1.08" (27.35)	3/8" 	1.50" (38)
QE6ST033F41S08	2.4 – 24 (3.3 – 33)	1,130	4.63 (2.1)	19.72" (501)	1.08" (27.35)	1/2" 	1.50" (38)
QE6ST033F61S06	2.4 – 24 (3.3 – 33)	1,130	4.85 (2.2)	21.42" (544)	1.08" (27.35)	3/8" 	1.50" (38)
QE6ST033F61S08	2.4 – 24 (3.3 – 33)	1,130	4.85 (2.2)	21.42" (544)	1.08" (27.35)	1/2" 	1.50" (38)
QE6ST033F81S06	2.4 – 24 (3.3 – 33)	1,130	5.07 (2.3)	23.39" (594)	1.08" (27.35)	3/8" 	1.50" (38)
QE6ST033F81S08	2.4 – 24 (3.3 – 33)	1,130	5.07 (2.3)	23.39" (594)	1.08" (27.35)	1/2" 	1.50" (38)
QE6ST050F41S08	3.7 – 36.75 (5.0 – 50)	760	4.63 (2.1)	19.72" (501)	1.08" (27.35)	1/2" 	1.50" (38)
QE6ST050F61S08	3.7 – 36.75 (5.0 – 50)	760	4.85 (2.2)	21.42" (544)	1.08" (27.35)	1/2" 	1.50" (38)
QE6ST050F81S08	3.7 – 36.75 (5.0 – 50)	760	5.07 (2.3)	21.42" (544)	1.08" (27.35)	1/2" 	1.50" (38)

# DC Electric Nutrunners

## Inline







### Manuals:

 16574477

 04580973

 16576951

 16575177

Model	 ft-lbs (Nm)	 rpm	 lbs (kg)	 in (mm)	 in (mm)	 in	 in (mm)
<b>DC</b> QE8 INLINE							
QE8ST055F41S08	4 – 40 (5.5 – 55)	1,470	6.61 (3)	21.97" (558)	1.19" (30.25)	1/2" □	1.50" (38)
QE8ST055F61S08	4 – 40 (5.5 – 55)	1,470	6.61 (3)	23.94" (608)	1.19" (30.25)	1/2" □	1.50" (38)
QE8ST055F81S08	4 – 40 (5.5 – 55)	1,470	6.61 (3)	25.95" (659)	1.19" (30.25)	1/2" □	1.50" (38)
QE8ST070F41S08	5.1 – 51 (7.0 – 70)	1,160	6.61 (3)	21.97" (558)	1.19" (30.25)	1/2" □	1.50" (38)
QE8ST070F61S08	5.1 – 51 (7.0 – 70)	1,160	6.61 (3)	23.94" (608)	1.19" (30.25)	1/2" □	1.50" (38)
QE8ST070F81S08	5.1 – 51 (7.0 – 70)	1,160	6.61 (3)	25.95" (659)	1.19" (30.25)	1/2" □	1.50" (38)
QE8ST090F41S08	6.6 – 66 (9.0 – 90)	900	6.61 (3)	21.97" (558)	1.19" (30.25)	1/2" □	1.50" (38)
QE8ST090F61S08	6.6 – 66 (9.0 – 90)	900	6.61 (3)	23.94" (608)	1.19" (30.25)	1/2" □	1.50" (38)
QE8ST090F81S08	6.6 – 66 (9.0 – 90)	900	6.61 (3)	25.95" (659)	1.19" (30.25)	1/2" □	1.50" (38)
QE8ST150F41S08	11 – 110 (15 – 150)	500	7.5 (3.4)	23.31" (592)	1.20" (30.55)	1/2" □	1.50" (38)
QE8ST150F61S08	11 – 110 (15 – 150)	500	7.5 (3.4)	25.32" (643)	1.20" (30.55)	1/2" □	1.50" (38)
QE8ST150F81S08	11 – 110 (15 – 150)	500	7.5 (3.4)	27.33" (694)	1.20" (30.55)	1/2" □	1.50" (38)
QE8ST230F62S12	17 – 169 (23 – 230)	340	12.13 (5.5)	28.23" (717)	1.43" (36.20)	3/4" □	1.50" (38)
QE8ST230F82S12	17 – 169 (23 – 230)	340	12.13 (5.5)	30.24" (768)	1.43" (36.20)	3/4" □	1.50" (38)
QE8ST230F02S12	17 – 169 (23 – 230)	340	12.13 (5.5)	32.25" (819)	1.43" (36.20)	3/4" □	1.50" (38)
QE8ST230F22S12	17 – 169 (23 – 230)	340	12.13 (5.5)	34.25" (870)	1.43" (36.20)	3/4" □	1.50" (38)

# DC Electric Nutrunners

## Inline Offset

### QE Series Inline Offsets

Delivers all the benefits of the standard QE Series Inline tool, and satisfies tight clearance requirements with an integral offset spindle. Non-contacting switches, heavy-duty gear train, and DC brushless motor create a durable package that will keep the line running smoothly and maintenance costs down.



QE6ZC020P52S06

#### Features

- Torque Range: 1.5 – 110 ft-lbs (2.0 – 150 Nm)
- Speeds: Adjustable to 1,840 rpm
- True closed-loop transducerized control provides exceptional accuracy
- Advanced tightening strategies and data and process communications
- Compact, high-speed, easily accessible controls
- Bright LEDs provide visible status indicators
- High-temperature motor protection
- Preventive maintenance alerts

#### Service and Accessories

##### Factory Direct Options for QE6 and QE8

Activation: Fifth Digit QE8Z( )

T = Trigger

L = Lever

E = Extended Lever

C = Machine Start

##### Manuals:

16574469

(Offset) P7780

16576951

16575169

##### Accessories:

Torque tubes

Cables

Smart socket trays

Socket pins







IC12D & C12M controllers

































Model	ft-lbs (Nm)	1 min. rpm	lbs (kg)	in (mm)	in (mm)	in	in (mm)
<b>DC QE6 OFFSET</b>							
QE6ZC020P42S06	1.5 – 14.7 (2 – 20)	1,840	5.51 (2.5)	26.14" (664)	0.69" (17.5)	3/8"	1.97" (50)
QE6ZC020P52S06	1.5 – 14.7 (2 – 20)	1,840	5.51 (2.5)	25.47" (647)	0.69" (17.5)	3/8"	1.97" (50)
QE6ZC028P52S06	2.0 – 20 (3 – 28)	1,360	5.51 (2.5)	25.47" (647)	0.69" (17.5)	3/8"	1.97" (50)
QE6ZC033P52S06	2.4 – 24 (3.3 – 33)	1,130	5.51 (2.5)	25.47" (647)	0.69" (17.5)	3/8"	1.97" (50)
QE6ZC050P52S06	3.7 – 36.75 (5 – 50)	760	5.51 (2.5)	25.47" (647)	0.69" (17.5)	3/8"	1.97" (50)

# DC Electric Nutrunners

## Offset

### Manuals:

-  16574477
-  (Offset) P7781
-  (Hi-Torque) 04580973
-  16576951
-  (Offset 055) P7780
-  16575177

Model	 ft-lbs (Nm)	 rpm	 lbs (kg)	 in (mm)	 in (mm)	 in	 in (mm)
<b>DC QE8 OFFSET</b>							
QE8ZC055F52S06	4 – 40 (5.5 – 55)	1,470	6.61 (3.0)	28.46" (723)	0.69" (17.5)	3/8" 	1.97" (50)
QE8ZC070F02S08	5.2 – 52 (7 – 70)	1,470	6.61 (3.0)	34.96" (888)	0.88" (22.35)	1/2" 	1.97" (50)
QE8ZC070F02S12	5.2 – 52 (7 – 70)	1,470	6.61 (3.0)	34.96" (888)	0.88" (22.35)	3/4" 	1.97" (50)
QE8ZC070F22S08	5.2 – 52 (7 – 70)	1,470	6.61 (3.0)	36.97" (939)	0.88" (22.35)	1/2" 	1.97" (50)
QE8ZC070F22S12	5.2 – 52 (7 – 70)	1,470	6.61 (3.0)	36.97" (939)	0.88" (22.35)	3/4" 	1.97" (50)
QE8ZC070F62S08	5.2 – 52 (7 – 70)	1,470	6.61 (3.0)	30.94" (786)	0.88" (22.35)	1/2" 	1.97" (50)
QE8ZC070F62S12	5.2 – 52 (7 – 70)	1,470	6.61 (3.0)	30.94" (786)	0.88" (22.35)	3/4" 	1.97" (50)
QE8ZC070F82S08	4 – 40 (5.5 – 55)	1,470	6.61 (3.0)	32.95" (837)	0.88" (22.35)	1/2" 	1.97" (50)
QE8ZC070F82S12	4 – 40 (5.5 – 55)	1,470	6.61 (3.0)	32.95" (837)	0.88" (22.35)	3/4" 	1.97" (50)
QE8ZC090F02S08	6.6 – 66 (9.0 – 90)	900	8.82 (4.0)	34.96" (888)	0.88" (22.35)	1/2" 	1.97" (50)
QE8ZC090F02S12	6.6 – 66 (9.0 – 90)	900	8.82 (4.0)	34.96" (888)	0.88" (22.35)	3/4" 	1.97" (50)
QE8ZC090F22S08	6.6 – 66 (9.0 – 90)	900	8.82 (4.0)	36.97" (939)	0.88" (22.35)	1/2" 	1.97" (50)
QE8ZC090F22S12	6.6 – 66 (9.0 – 90)	900	8.82 (4.0)	36.97" (939)	0.88" (22.35)	3/4" 	1.97" (50)
QE8ZC090F62S08	6.6 – 66 (9.0 – 90)	900	8.82 (4.0)	30.94" (786)	0.88" (22.35)	1/2" 	1.97" (50)
QE8ZC090F62S12	6.6 – 66 (9.0 – 90)	900	8.82 (4.0)	30.94" (786)	0.88" (22.35)	3/4" 	1.97" (50)
QE8ZC090F82S08	6.6 – 66 (9.0 – 90)	900	8.82 (4.0)	32.95" (837)	0.88" (22.35)	1/2" 	1.97" (50)
QE8ZC090F82S12	6.6 – 66 (9.0 – 90)	900	8.82 (4.0)	32.95" (837)	0.88" (22.35)	3/4" 	1.97" (50)
QE8ZC150F02S08	11 – 110 (15 – 150)	500	8.82 (4.0)	34.96" (888)	0.88" (22.35)	1/2" 	1.97" (50)
QE8ZC150F02S12	11 – 110 (15 – 150)	500	8.82 (4.0)	34.96" (888)	0.88" (22.35)	3/4" 	1.97" (50)
QE8ZC150F22S08	11 – 110 (15 – 150)	500	8.82 (4.0)	36.97" (939)	0.88" (22.35)	1/2" 	1.97" (50)
QE8ZC150F22S12	11 – 110 (15 – 150)	500	8.82 (4.0)	36.97" (939)	0.88" (22.35)	3/4" 	1.97" (50)
QE8ZC150F62S08	11 – 110 (15 – 150)	500	8.82 (4.0)	30.94" (786)	0.88" (22.35)	1/2" 	1.97" (50)
QE8ZC150F62S12	11 – 110 (15 – 150)	500	8.82 (4.0)	30.94" (786)	0.88" (22.35)	3/4" 	1.97" (50)
QE8ZC150F82S08	11 – 110 (15 – 150)	500	8.82 (4.0)	32.95" (837)	0.88" (22.35)	1/2" 	1.97" (50)
QE8ZC150F82S12	11 – 110 (15 – 150)	500	8.82 (4.0)	32.95" (837)	0.88" (22.35)	3/4" 	1.97" (50)

# DC Electric Nutrunners

## Angle

### QE Series Angles

A proven world-class combination — QE tools and IC Series controllers team up to provide superior accuracy and durability and meet your critical fastening requirements. The non-contacting switches, heavy-duty gear train, and DC brushless motor create a durable package, while the compact, ergonomic design and easily accessible controls help operators keep production lines running smoothly.



QE4AT020PA2S06

#### Features

- Torque Range: 1 – 294 ft-lbs (1.3 – 400 Nm)
- Speeds: Adjustable to 1230 rpm
- True closed-loop transducerized control provides exceptional accuracy
- Advanced tightening strategies and data and process communications
- TactAlert provides positive feedback to the operator without distracting from the task
- Compact, high-speed, easily accessible controls
- Easy-to-use reverse ring
- Bright LEDs provide visible status indicators
- Comfortable ergonomic grip
- High-temperature motor protection
- Preventive maintenance alerts

#### Service and Accessories

##### Factory Direct Options for QE4, QE6 and QE8

Activation: Fifth Digit QE8A( )

T = Trigger

L = Lever

E = Extended Lever

C = Machine Start

Mounting: Ninth Digit QE8AT150( )

P = No Mount\*

F = Flanged Mount\*\*

R = Reaction Bar Kit\*

B = Flange Mount Kit\*

J = Two-Piece Mounting Plate

\* Not available on 225 or 400 Nm tools

\*\* Not available on QE4

##### Accessories:

- Torque arms
- Torque tubes
- Cables
- Swivel hangers
- Suspension bails
- Smart socket trays
- Quick-change socket pins
- Mounting flanges
- Extended lever
- IC12D & C12M controllers

##### Manuals:



16574451



16576951









16574451

Model	ft-lbs (Nm)	rpm	lbs (kg)	in (mm)	in (mm)	in
<b>DC QE4 ANGLE</b>						
QE4AT013PA2H04	1 – 9.5 (1.3 – 13)	1,200	2.87 (1.3)	15.08" (383)	0.51" (12.9)	1/4"
QE4AT013PA2Q04	1 – 9.5 (1.3 – 13)	1,200	2.87 (1.3)	15.08" (383)	0.51" (12.9)	1/4"
QE4AT013PA2S04	1 – 9.5 (1.3 – 13)	1,200	2.87 (1.3)	15.08" (383)	0.51" (12.9)	1/4"
QE4AT013PA2S06	1 – 9.5 (1.3 – 13)	1,200	2.87 (1.3)	15.08" (383)	0.51" (12.9)	3/8"
QE4AT020PA2H04	1.5 – 14.7 (2 – 20)	820	2.87 (1.3)	15.08" (383)	0.51" (12.9)	1/4"
QE4AT020PA2Q04	1.5 – 14.7 (2 – 20)	820	2.87 (1.3)	15.08" (383)	0.51" (12.9)	1/4"
QE4AT020PA2S04	1.5 – 14.7 (2 – 20)	820	2.87 (1.3)	15.08" (383)	0.51" (12.9)	1/4"
QE4AT020PA2S06	1.5 – 14.7 (2 – 20)	820	2.87 (1.3)	15.08" (383)	0.51" (12.9)	3/8"
QE4AT027PA4S06	2 – 19.8 (2.7 – 27)	600	2.87 (1.3)	15.24" (387)	0.67" (17.0)	3/8"
QE4AT027PA4S08	2 – 19.8 (2.7 – 27)	600	2.87 (1.3)	15.24" (387)	0.67" (17.0)	1/2"
QE4AT034PA4S06	2.5 – 25 (3.4 – 34)	470	2.87 (1.3)	15.24" (387)	0.67" (17.0)	3/8"
QE4AT034PA4S08	2.5 – 25 (3.4 – 34)	470	2.87 (1.3)	15.24" (387)	0.67" (17.0)	1/2"















# DC Electric Nutrunners

## Angle

### Manuals:

- |   |   |
|---|---|
|  16574469 QE6 Series |  16574477 QE8 Series |
|  16576951            |  04580973            |
|  16575169            |  16576951            |
|   |  16575177            |



Model	 ft-lbs (Nm)	 rpm	 lbs (kg)	 in (mm)	 in (mm)	 in
<b>DC QE6 ANGEL</b>						
QE6AT030PA2S06	2.2 – 22 (3 – 30)	1,230	4.19 (1.9)	17.40" (442)	0.50" (12.8)	3/8" 
QE6AT030PA4S06	2.2 – 22 (3 – 30)	1,230	4.19 (1.9)	17.60" (447)	0.67" (17.0)	3/8" 
QE6AT030PA4S08	2.2 – 22 (3 – 30)	1,230	4.19 (1.9)	17.60" (447)	0.67" (17.0)	1/2" 
QE6AT040PA4S06	3 – 29.4 (4 – 40)	910	4.19 (1.9)	17.60" (447)	0.67" (17.0)	3/8" 
QE6AT040PA4S08	3 – 29.4 (4 – 40)	910	4.19 (1.9)	17.60" (447)	0.67" (17.0)	1/2" 
QE6AT055PA5S08	4 – 40 (5.5 – 55)	650	4.41 (2.0)	17.80" (452)	0.84" (21.4)	1/2" 
QE6AT080PA5S08	5.9 – 58.8 (8 – 80)	440	4.41 (2.0)	17.80" (452)	0.84" (21.4)	1/2" 
<b>DC QE8 ANGEL</b>						
QE8AT065FA5S08	4.8 – 47.8 (6.5 – 65)	1,200	6.39 (2.9)	20.28" (515)	0.84" (21.4)	1/2" 
QE8AT065PA5S08	4.8 – 47.8 (6.5 – 65)	1,200	6.39 (2.9)	20.28" (515)	0.84" (21.4)	1/2" 
QE8AT065FA6S08	4.8 – 47.8 (6.5 – 65)	1,200	6.61 (3.0)	20.47" (520)	0.96" (24.3)	1/2" 
QE8AT065PA6S08	4.8 – 47.8 (6.5 – 65)	1,200	6.61 (3.0)	20.47" (520)	0.96" (24.3)	1/2" 
QE8AT070FA5S08	5.1 – 51 (7.0 – 70)	1,100	6.39 (2.9)	20.28" (515)	0.84" (21.4)	1/2" 
QE8AT070PA5S08	5.1 – 51 (7.0 – 70)	1,100	6.39 (2.9)	20.28" (515)	0.84" (21.4)	1/2" 
QE8AT070FA6S08	5.1 – 51 (7.0 – 70)	1,100	6.61 (3.0)	20.47" (520)	0.96" (24.3)	1/2" 
QE8AT070PA6S08	5.1 – 51 (7.0 – 70)	1,100	6.61 (3.0)	20.47" (520)	0.96" (24.3)	1/2" 
QE8AT090FA5S08	6.6 – 66 (9.0 – 90)	850	6.39 (2.9)	20.28" (515)	0.84" (21.4)	1/2" 
QE8AT090PA5S08	6.6 – 66 (9.0 – 90)	850	6.39 (2.9)	20.28" (515)	0.84" (21.4)	1/2" 
QE8AT090FA6S08	6.6 – 66 (9.0 – 90)	850	6.61 (3.0)	20.47" (520)	0.96" (24.3)	1/2" 
QE8AT090PA6S08	6.6 – 66 (9.0 – 90)	850	6.61 (3.0)	20.47" (520)	0.96" (24.3)	1/2" 
QE8AT115FA6S08	8.5 – 84.5 (11.5 – 115)	660	6.61 (3.0)	20.47" (520)	0.96" (24.3)	1/2" 
QE8AT115PA6S08	8.5 – 84.5 (11.5 – 115)	660	6.61 (3.0)	20.47" (520)	0.96" (24.3)	1/2" 
QE8AT150FA6S08	11 – 110 (15 – 150)	510	6.83 (3.1)	20.47" (520)	0.96" (24.3)	1/2" 
QE8AT150PA6S08	11 – 110 (15 – 150)	510	6.83 (3.1)	20.47" (520)	0.96" (24.3)	1/2" 
QE8AT225FA7S12	16.5 – 165 (22.5 – 225)	310	9.04 (4.1)	22.68" (576)	1.19" (30.15)	3/4" 
QE8AT225PA7S12	16.5 – 165 (22.5 – 225)	310	9.04 (4.1)	22.68" (576)	1.19" (30.15)	3/4" 
QE8AT400FA8S12	29 – 294 (40 – 400)	170	13.23 (6.0)	25.08" (637)	1.40" (35.6)	3/4" 

# DC Electric Fixtured Spindles

## QM Series Inline

Heavy-duty motors offer high accuracy and control over your fastening application. Whether used in single spindle or multiple spindle configurations, these world-class tools provide top-quality performance and long life.



QM3SS008H...

### Features

- Torque range: 0.59 – 1617 ft-lbs (0.8 – 2200 Nm)
- Speeds: Adjustable to 1382 rpm
- Better than 5 percent capability
- High-duty cycle motors and components provide excellent durability
- External electronics pod simplifies integration
- Available with or without spindles in a variety of length and drive options

Body style specified in fourth digit: ex, QM3( )S008H62S06  
**S** = Motor with spindle, **M** = Motor without spindle

Spindle spring tension specified in ninth digit: ex, QM3SS008( )62S06  
**H** = Heavy spring, **L** = Light spring, **S** = Solid, non-floating

Standard spindle float is 2" (50 mm)

Models specified in the table below have spindles with heavy spindle springs

### Manuals:

- 04581310
- 04581278
- 04581351



The Tool connector can be mounted away from the motor to make sure that the cable is managed in the optimum position.

Model	ft-lbs (Nm)	rpm	lbs (kg)	in (mm)	in (mm)	in	in (mm)
<b>DC QM3 INLINE</b>							
QM3SS008H62S06	0.59 – 5.9 (0.8 – 8)	1382	5.3 (2.4)	17.7" (449)	0.67" (17)	3/8"	6" (150)
QM3SS008H62S08	0.59 – 5.9 (0.8 – 8)	1382	5.3 (2.4)	17.7" (449)	0.67" (17)	1/2"	6" (150)
QM3SS008H92S06	0.59 – 5.9 (0.8 – 8)	1382	5.6 (2.4)	20.6" (524)	0.67" (17)	3/8"	9" (225)
QM3SS008H92S08	0.59 – 5.9 (0.8 – 8)	1382	5.6 (2.4)	20.6" (524)	0.67" (17)	1/2"	9" (225)
QM3SS008H22S06	0.59 – 5.9 (0.8 – 8)	1382	5.9 (2.7)	23.6" (599)	0.67" (17)	3/8"	12" (300)
QM3SS008H22S08	0.59 – 5.9 (0.8 – 8)	1382	5.9 (2.7)	23.6" (599)	0.67" (17)	1/2"	12" (300)
QM3SS012H62S06	0.9 – 8.8 (1.2 – 12)	927	5.3 (2.4)	17.7" (449)	0.67" (17)	3/8"	6" (150)
QM3SS012H62S08	0.9 – 8.8 (1.2 – 12)	927	5.3 (2.4)	17.7" (449)	0.67" (17)	1/2"	6" (150)
QM3SS012H92S06	0.9 – 8.8 (1.2 – 12)	927	5.6 (2.5)	20.6" (524)	0.67" (17)	3/8"	9" (225)
QM3SS012H92S08	0.9 – 8.8 (1.2 – 12)	927	5.6 (2.5)	20.6" (524)	0.67" (17)	1/2"	9" (225)
QM3SS012H22S06	0.9 – 8.8 (1.2 – 12)	927	5.9 (2.7)	23.6" (599)	0.67" (17)	3/8"	12" (300)
QM3SS012H22S08	0.9 – 8.8 (1.2 – 12)	927	5.9 (2.7)	23.6" (599)	0.67" (17)	1/2"	12" (300)
QM3SS016H62S06	1.2 – 11.7 (1.6 – 16)	686	5.3 (2.4)	17.7" (449)	0.67" (17)	3/8"	6" (150)
QM3SS016H62S08	1.2 – 11.7 (1.6 – 16)	686	5.3 (2.4)	17.7" (449)	0.67" (17)	1/2"	6" (150)
QM3SS016H92S06	1.2 – 11.7 (1.6 – 16)	686	5.6 (2.5)	20.6" (524)	0.67" (17)	3/8"	9" (225)
QM3SS016H92S08	1.2 – 11.7 (1.6 – 16)	686	5.6 (2.5)	20.6" (524)	0.67" (17)	1/2"	9" (225)
QM3SS016H22S06	1.2 – 11.7 (1.6 – 16)	686	5.9 (2.7)	23.6" (599)	0.67" (17)	3/8"	12" (300)
QM3SS016H22S08	1.2 – 11.7 (1.6 – 16)	686	5.9 (2.7)	23.6" (599)	0.67" (17)	1/2"	12" (300)
QM3SS020H62S06	1.5 – 14.7 (2 – 20)	545	5.3 (2.4)	17.7" (449)	0.67" (17)	3/8"	6" (150)
QM3SS020H62S08	1.5 – 14.7 (2 – 20)	545	5.3 (2.4)	17.7" (449)	0.67" (17)	1/2"	6" (150)
QM3SS020H92S06	1.5 – 14.7 (2 – 20)	545	5.6 (2.5)	20.6" (524)	0.67" (17)	3/8"	9" (225)
QM3SS020H92S08	1.5 – 14.7 (2 – 20)	545	5.6 (2.5)	20.6" (524)	0.67" (17)	1/2"	9" (225)
QM3SS020H22S06	1.5 – 14.7 (2 – 20)	545	5.9 (2.7)	23.6" (599)	0.67" (17)	3/8"	12" (300)
QM3SS020H22S08	1.5 – 14.7 (2 – 20)	545	5.9 (2.7)	23.6" (599)	0.67" (17)	1/2"	12" (300)





# DC Electric Fixtured Spindles

## Manuals:































-  04581328 QM5 Series
-  04581278
-  04581369

---

-  04581336 QM7 Series
-  04581278
-  04581377





QM7SS190H...

Model	 ft-lbs (Nm)	 rpm	 lbs (kg)	 in (mm)	 in (mm)	 in	 in (mm)
<b>DC QM5 INLINE</b>							
QM5SS035H62S06	2.6 – 25.7 (3.5 – 35)	590	8.6 (3.9)	20.6" (523)	0.87" (22)	3/8" 	6" (150)
QM5SS035H62S08	2.6 – 25.7 (3.5 – 35)	590	8.6 (3.9)	20.6" (523)	0.87" (22)	1/2" 	6" (150)
QM5SS035H92S06	2.6 – 25.7 (3.5 – 35)	590	8.9 (4.1)	23.5" (598)	0.87" (22)	3/8" 	9" (225)
QM5SS035H92S08	2.6 – 25.7 (3.5 – 35)	590	8.9 (4.1)	23.5" (598)	0.87" (22)	1/2" 	9" (225)
QM5SS035H22S06	2.6 – 25.7 (3.5 – 35)	590	9.2 (4.2)	26.5" (673)	0.87" (22)	3/8" 	12" (300)
QM5SS035H22S08	2.6 – 25.7 (3.5 – 35)	590	9.2 (4.2)	26.5" (673)	0.87" (22)	1/2" 	12" (300)
QM5SS055H62S06	4.1 – 40.4 (5.5 – 55)	507	8.6 (3.9)	20.6" (523)	0.87" (22)	3/8" 	6" (150)
QM5SS055H62S08	4.1 – 40.4 (5.5 – 55)	507	8.6 (3.9)	20.6" (523)	0.87" (22)	1/2" 	6" (150)
QM5SS055H92S06	4.1 – 40.4 (5.5 – 55)	507	8.9 (4.1)	23.5" (598)	0.87" (22)	3/8" 	9" (225)
QM5SS055H92S08	4.1 – 40.4 (5.5 – 55)	507	8.9 (4.1)	23.5" (598)	0.87" (22)	1/2" 	9" (225)
QM5SS055H22S06	4.1 – 40.4 (5.5 – 55)	507	9.2 (4.2)	26.5" (673)	0.87" (22)	3/8" 	12" (300)
QM5SS055H22S08	4.1 – 40.4 (5.5 – 55)	507	9.2 (4.2)	26.5" (673)	0.87" (22)	1/2" 	12" (300)
QM5SS090H62S08	6.6 – 66 (9 – 90)	280	8.9 (4.1)	20.6" (523)	0.87" (22)	1/2" 	6" (150)
QM5SS090H92S08	6.6 – 66 (9 – 90)	280	9.2 (4.2)	23.5" (598)	0.87" (22)	1/2" 	9" (225)
QM5SS090H22S08	6.6 – 66 (9 – 90)	280	8.6 (3.9)	26.5" (673)	0.87" (22)	1/2" 	12" (300)
<b>DC QM7 INLINE</b>							
QM7SS190H62S08	14 – 139 (19 – 190)	273	18.5 (8.4)	25.4" (645)	1.38" (35)	1/2" 	6" (150)
QM7SS190H62S12	14 – 139 (19 – 190)	273	18.5 (8.4)	25.4" (645)	1.38" (35)	3/4" 	6" (150)
QM7SS190H92S08	14 – 139 (19 – 190)	273	19.0 (8.6)	28.3" (720)	1.38" (35)	1/2" 	9" (225)
QM7SS190H92S12	14 – 139 (19 – 190)	273	19.1 (8.7)	28.3" (720)	1.38" (35)	3/4" 	9" (225)
QM7SS190H22S08	14 – 139 (19 – 190)	273	19.5 (8.9)	31.3" (794)	1.38" (35)	1/2" 	12" (300)
QM7SS190H22S12	14 – 139 (19 – 190)	273	19.6 (8.9)	31.3" (794)	1.38" (35)	3/4" 	12" (300)
QM7SS220H62S12	16.2 – 161 (22 – 220)	233	18.5 (8.4)	25.4" (645)	1.38" (35)	3/4" 	6" (150)
QM7SS220H92S12	16.2 – 161 (22 – 220)	233	19.1 (8.7)	28.3" (720)	1.38" (35)	3/4" 	9" (225)
QM7SS250H22S12	16.2 – 161 (22 – 220)	233	19.6 (8.9)	31.3" (794)	1.38" (35)	3/4" 	12" (300)



































# DC Electric Fixtured Spindles

## Manuals:

-  04581344
-  04581278
-  04581385



QM9SS520H...

Model	 ft-lbs (Nm)	 rpm	 lbs (kg)	 in (mm)	 in (mm)	 in	 in (mm)
<b>DC QM9 INLINE</b>							
QM9SS315H62S12	24 – 231 (31.5 – 315)	278	41.0 (18.6)	28.0" (711)	1.75" (44.5)	3/4" 	6" (150)
QM9SS315H62S16	24 – 231 (31.5 – 315)	278	41.2 (18.7)	30.9" (786)	1.75" (44.5)	1" 	6" (150)
QM9SS315H92S12	24 – 231 (31.5 – 315)	278	42.1 (19.1)	33.9" (860)	1.75" (44.5)	3/4" 	9" (225)
QM9SS315H92S16	24 – 231 (31.5 – 315)	278	42.3 (19.2)	28.0" (711)	1.75" (44.5)	1" 	9" (225)
QM9SS315H22S12	24 – 231 (31.5 – 315)	278	43.0 (19.52)	30.9" (786)	1.75" (44.5)	3/4" 	12" (300)
QM9SS315H22S16	24 – 231 (31.5 – 315)	278	43.2 (19.61)	33.9" (860)	1.75" (44.5)	1" 	12" (300)
QM9SS435H62S12	32 – 319 (43.5 – 435)	203	41.0 (18.6)	28.0" (711)	1.75" (44.5)	3/4" 	6" (150)
QM9SS435H62S16	32 – 319 (43.5 – 435)	203	41.2 (18.7)	30.9" (786)	1.75" (44.5)	1" 	6" (150)
QM9SS435H92S12	32 – 319 (43.5 – 435)	203	42.1 (19.1)	33.9" (860)	1.75" (44.5)	3/4" 	9" (225)
QM9SS435H92S16	32 – 319 (43.5 – 435)	203	42.3 (19.2)	28.0" (711)	1.75" (44.5)	1" 	9" (225)
QM9SS435H22S12	32 – 319 (43.5 – 435)	203	43.0 (19.5)	30.9" (786)	1.75" (44.5)	3/4" 	12" (300)
QM9SS435H22S16	32 – 319 (43.5 – 435)	203	43.2 (19.6)	33.9" (860)	1.75" (44.5)	1" 	12" (300)
QM9SS520H62S12	38 – 382 (52 – 520)	170	41.0 (18.6)	28.0" (711)	1.75" (44.5)	3/4" 	6" (150)
QM9SS520H62S16	38 – 382 (52 – 520)	170	41.2 (18.7)	30.9" (786)	1.75" (44.5)	1" 	6" (150)
QM9SS520H92S12	38 – 382 (52 – 520)	170	42.1 (19.1)	33.9" (860)	1.75" (44.5)	3/4" 	9" (225)
QM9SS520H92S16	38 – 382 (52 – 520)	170	42.3 (19.2)	28.0" (711)	1.75" (44.5)	1" 	9" (225)
QM9SS520H22S12	38 – 382 (52 – 520)	170	43.0 (19.5)	30.9" (786)	1.75" (44.5)	3/4" 	12" (300)
QM9SS520H22S16	38 – 382 (52 – 520)	170	43.2 (19.6)	33.9" (860)	1.75" (44.5)	1" 	12" (300)
QM9SS650H62S16	48 – 477 (65 – 650)	136	41.2 (18.7)	28.0" (711)	1.75" (44.5)	1" 	6" (150)
QM9SS650H92S16	48 – 477 (65 – 650)	136	42.3 (19.2)	30.9" (786)	1.75" (44.5)	1" 	9" (225)
QM9SS650H22S16	48 – 477 (65 – 650)	136	43.2 (19.6)	33.9" (860)	1.75" (44.5)	1" 	12" (300)
QM9SS01KH22S16	74 – 735 (100 – 1000)	51	54.0 (24.5)	33.7" (857)	2.55" (65)	1" 	6" (150)
QM9SS01KH62S16	74 – 735 (100 – 1000)	51	55.1 (25.0)	36.7" (932)	2.55" (65)	1" 	9" (225)
QM9SS01KH92S16	74 – 735 (100 – 1000)	51	56.0 (25.4)	39.6" (1006)	2.55" (65)	1" 	12" (300)
QM9SS15CH62S24	110 – 1100 (150 – 1500)	51	70.6 (32.0)	34.2" (869)	2.88" (73)	1-1/2" 	6" (150)
QM9SS18CH62S24	132 – 1323 (180 – 1800)	37	70.6 (32.0)	34.2" (869)	2.88" (73)	1-1/2" 	6" (150)
QM9SS20CH62S24	147 – 1470 (200 – 2000)	31	70.6 (32.0)	34.2" (869)	2.88" (73)	1-1/2" 	6" (150)
QM9SS25CH62S24	162 – 1617 (220 – 2500)	25	70.6 (32.0)	34.2" (869)	2.88" (73)	1-1/2" 	6" (150)

# DC Electric Fixtured Spindles

## QM Series Offset

Heavy-duty motors offer high accuracy and control in tight clearance applications. Whether used in single-spindle or multiple-spindle configurations, these world-class tools provide top-quality performance and long life.

### Features

- Torque range: 2.6 – 330 ft-lbs (3.5 – 450 Nm)
- Speeds: Adjustable to 590 rpm
- Better than 5 percent capability
- High-duty-cycle motors and components provide excellent durability in tight clearance applications
- External electronics pod simplifies integration
- Available in a variety of length and drive options
- Transducer mounted after offset gearbox



Spindle spring tension specified in ninth digit: ex, QM3ZS008( )62S06

























**H** = Heavy spring, **L** = Light spring,  
**S** = Solid, non-floating

Standard spindle float is 2" (50 mm)

Models specified in the table below have spindles with heavy spindle springs

### Manuals:

- |  |            |  |            |
|--|------------|--|------------|
|  04581328   | QM5 Series |  04581336   | QM7 Series |
|  04581278 |            |  04581278 |            |
|  04581369 |            |  04581377 |            |

Model	 ft-lbs (Nm)	 rpm	 lbs (kg)	 in (mm)	 in (mm)	 in	 in (mm)
<b>DC QM5 OFFSET</b>							
QM5ZS035H62S06	2.6 – 25.7 (3.5 – 35)	590	11.18 (5.1)	23" (591)	0.69" (17.5)	3/8" 	6" (150)
QM5ZS035H62S08	2.6 – 25.7 (3.5 – 35)	590	11.20 (5.1)	23" (591)	0.69" (17.5)	1/2" 	6" (150)
QM5ZS035H92S06	2.6 – 25.7 (3.5 – 35)	590	11.49 (5.2)	26" (666)	0.69" (17.5)	3/8" 	9" (225)
QM5ZS035H92S08	2.6 – 25.7 (3.5 – 35)	590	11.51 (5.2)	26" (666)	0.69" (17.5)	1/2" 	9" (225)
QM5ZS035H22S06	2.6 – 25.7 (3.5 – 35)	590	11.80 (5.4)	29" (741)	0.69" (17.5)	3/8" 	12" (300)
QM5ZS035H22S08	2.6 – 25.7 (3.5 – 35)	590	11.82 (5.4)	29" (741)	0.69" (17.5)	1/2" 	12" (300)
QM5ZS050H62S06	3.7 – 36.7 (5 – 50)	507	11.18 (5.1)	23" (591)	0.69" (17.5)	3/8" 	6" (150)
QM5ZS050H62S08	3.7 – 36.7 (5 – 50)	507	11.20 (5.1)	23" (591)	0.69" (17.5)	1/2" 	6" (150)
QM5ZS050H92S06	3.7 – 36.7 (5 – 50)	507	11.49 (5.2)	26" (666)	0.69" (17.5)	3/8" 	9" (225)
QM5ZS050H92S08	3.7 – 36.7 (5 – 50)	507	11.51 (5.2)	26" (666)	0.69" (17.5)	1/2" 	9" (225)
QM5ZS050H22S06	3.7 – 36.7 (5 – 50)	507	11.80 (5.4)	29" (741)	0.69" (17.5)	3/8" 	12" (300)
QM5ZS050H22S08	3.7 – 36.7 (5 – 50)	507	11.82 (5.4)	29" (741)	0.69" (17.5)	1/2" 	12" (300)
<b>DC QM7 OFFSET</b>							
QM7ZS150H62S08	11 – 110 (15 – 150)	273	25.58 (11.6)	29" (749)	0.87" (22.0)	3/8" 	6" (150)
QM7ZS150H92S08	11 – 110 (15 – 150)	273	26.02 (11.8)	32" (824)	0.87" (22.0)	3/8" 	9" (225)
QM7ZS150H22S08	11 – 110 (15 – 150)	273	26.56 (12.5)	35" (898)	0.87" (22.0)	3/8" 	12" (300)
QM7ZS150H62S12	11 – 110 (15 – 150)	273	25.67 (11.6)	29" (749)	0.87" (22.0)	1/2" 	6" (150)
QM7ZS150H92S12	11 – 110 (15 – 150)	273	26.17 (11.9)	32" (824)	0.87" (22.0)	1/2" 	9" (225)
QM7ZS150H22S12	11 – 110 (15 – 150)	273	26.66 (12.1)	35" (898)	0.87" (22.0)	1/2" 	12" (300)

























# DC Electric Fixtured Spindles

Manuals:

 04581344

 04581278

 04581358

Model	 ft-lbs (Nm)	 rpm	 lbs (kg)	 in (mm)	 in (mm)	 in	 in (mm)
<b>DC QM9 OFFSET</b>							
QM9ZS315H62S12	24 – 231 (31.5 – 315)	278	54.24 (24.6)	33" (831)	1.24" (31.5)	3/4" 	6" (150)
QM9ZS315H92S12	24 – 231 (31.5 – 315)	278	55.35 (25.1)	36" (906)	1.24" (31.5)	3/4" 	9" (225)
QM9ZS315H22S12	24 – 231 (31.5 – 315)	278	56.45 (25.6)	39" (980)	1.24" (31.5)	3/4" 	12" (300)
QM9ZS315H62S16	24 – 231 (31.5 – 315)	278	54.40 (24.7)	33" (831)	1.24" (31.5)	1" 	6" (150)
QM9ZS315H92S16	24 – 231 (31.5 – 315)	278	55.52 (25.2)	36" (906)	1.24" (31.5)	1" 	9" (225)
QM9ZS315H22S16	24 – 231 (31.5 – 315)	278	56.27 (25.5)	39" (980)	1.24" (31.5)	1" 	12" (300)
QM9ZS435H62S12	32 – 319 (43.5 – 435)	203	54.24 (24.6)	33" (831)	1.24" (31.5)	3/4" 	6" (150)
QM9ZS435H92S12	32 – 319 (43.5 – 435)	203	55.35 (25.1)	36" (906)	1.24" (31.5)	3/4" 	9" (225)
QM9ZS435H22S12	32 – 319 (43.5 – 435)	203	56.45 (25.6)	39" (980)	1.24" (31.5)	3/4" 	12" (300)
QM9ZS435H62S16	32 – 319 (43.5 – 435)	203	54.40 (24.7)	33" (831)	1.24" (31.5)	1" 	6" (150)
QM9ZS435H92S16	32 – 319 (43.5 – 435)	203	55.52 (25.2)	36" (906)	1.24" (31.5)	1" 	9" (225)
QM9ZS435H22S16	32 – 319 (43.5 – 435)	203	56.27 (25.5)	39" (980)	1.24" (31.5)	1" 	12" (300)
QM9ZS450H62S12	33 – 330 (45 – 450)	170	54.24 (24.6)	33" (831)	1.24" (31.5)	3/4" 	6" (150)
QM9ZS450H92S12	33 – 330 (45 – 450)	170	55.35 (25.1)	36" (906)	1.24" (31.5)	3/4" 	9" (225)
QM9ZS450H22S12	33 – 330 (45 – 450)	170	56.45 (25.6)	39" (980)	1.24" (31.5)	3/4" 	12" (300)
QM9ZS450H62S16	33 – 330 (45 – 450)	170	54.40 (24.7)	33" (831)	1.24" (31.5)	1" 	6" (150)
QM9ZS450H92S16	33 – 330 (45 – 450)	170	55.52 (25.2)	36" (906)	1.24" (31.5)	1" 	9" (225)
QM9ZS450H22S16	33 – 330 (45 – 450)	170	56.27 (25.5)	39" (980)	1.24" (31.5)	1" 	12" (300)

# Fixtured Fastening Systems

## Fixtures

*Modular designs provide easy customization of open-or closed-frame vertical, horizontal, and horizontal rotating. Multiple fixtures for DC electric and air spindles.*

### Features

- Pre-engineered modular designs provide quick quoting, configuration, and delivery
- Systems combine world-class portfolio of tools, controllers, handling devices, and fixtures to deliver superior ergonomics, reduced cycle times, more even clamp loads, and exceptional durability
- Fully configurable interface and handle options for optimal ergonomics
- Added compliance control on vertical lift (up, down and neutral)
- Multiple suspension and torque reaction options include: balancers, torque tubes, articulating arms, jib cranes, or pneumatic suspensions



## DC Electric Fixtured Fastening Systems

### Multiples

## Handle & Operator Interface

*Modular designs provide optimal flexibility in selecting the exact operator interfaces that you need for your Fixtured Fastening Systems.*

### Features

- Designed to provide maximum flexibility
- Options for trigger, pneumatic actuation mount for optimal positioning
- Operator interface include configurable LED display that shows individual and master OK/NOK signals for up to six spindles. Open positions provide space for interface options to enhance control and signaling
- Contact your DSM/ Customer service for further assistance.



# DC Electric Controllers



IC12D



IC12M

## IC12D Controllers

The Ingersoll Rand IC12D Insight controllers give you full closed-loop control in a compact package. With features like a 1/4 VGA color display and easy, intuitive, quick set-up programming, the IC12D provides unmatched performance.

### Standard Features

- 1/4 VGA color display (IC12D)
- Full keypad and navigation keys (IC12D)
- One-line LED Display (IC12M)
- Ethernet connection
- RS232
- Eight I/O
- 1000 cycle storage (IC12D)
- 200 cycle storage (IC12M)
- Eight instant configurations
- 256 stored configurations
- Dual power mode 120-240 V AC
- Quick set-up feature
- Small footprint (mm) 152h x 191w x 238d

### Optional Features

- All units are available with the following options:
- 115 V AC power cord
  - 220 V AC power cord
  - 230 V AC EU pigtail power cord
  - Cabinet mount / wall mount
  - PFCS software package
  - Plus software package
  - 16 additional I/O
  - Fieldbus cards

### Languages Available

- Chinese
- English
- French
- German
- Italian
- Spanish

### Service and Accessories

- Complete installation and repair service available
- Bit selector tray
- Socket selector: IC-socket-x
- Light tower, see page 47
- Transfer key: 80150113
- Custom racks

### Manuals:

04581732

## IC Series DC Electric Controllers

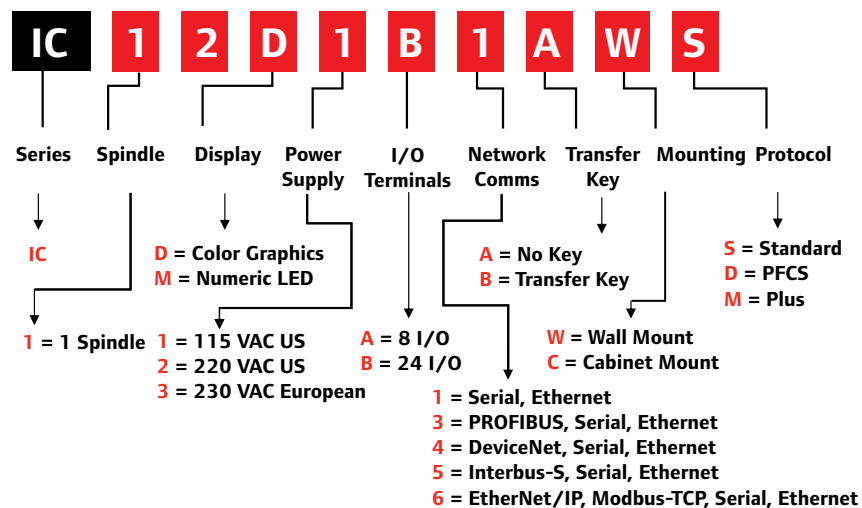

# DC Electric Controllers

IC12D Model	IC12M Model	Power Cord	Number of Input/Outputs	Communication Package
IC12D1A1AWS	IC12M1A1AWS	115 V AC USA	8	Ethernet and Serial
IC12D2A1AWS	IC12M2A1AWS	220 V AC USA	8	Ethernet and Serial
IC12D1A1BWS	IC12M1A1BWS	115 V AC USA	8	Ethernet and Serial
IC12D2A1BWS	IC12M2A1BWS	220 V AC USA	8	Ethernet and Serial
IC12D3A1BWS	IC12M2A1BWS	230 V AC Europe	8	Ethernet and Serial
IC12D1A3AWS	IC12M1A3AWS	115 V AC USA	8	PROFIBUS, Ethernet, and Serial
IC12D2A3AWS	IC12M2A3AWS	220 V AC USA	8	PROFIBUS, Ethernet, and Serial
IC12D1A3BWS	IC12M1A3BWS	115 V AC USA	8	PROFIBUS, Ethernet, and Serial
IC12D2A3BWS	IC12M2A3BWS	220 V AC USA	8	PROFIBUS, Ethernet, and Serial
IC12D3A3BWS	IC12M2A3BWS	230 V AC Europe	8	PROFIBUS, Ethernet, and Serial
IC12D1A4AWS	IC12M1A4AWS	115 V AC USA	8	DeviceNet, Ethernet, and Serial
IC12D2A4AWS	IC12M2A4AWS	220 V AC USA	8	DeviceNet, Ethernet, and Serial
IC12D1A4BWS	IC12M1A4BWS	115 V AC USA	8	DeviceNet, Ethernet, and Serial
IC12D2A4BWS	IC12M2A4BWS	220 V AC USA	8	DeviceNet, Ethernet, and Serial
IC12D3A4BWS	IC12M2A4BWS	230 V AC Europe	8	DeviceNet, Ethernet, and Serial
IC12D1A5AWS	IC12M1A5AWS	115 V AC USA	8	Interbus-S, Ethernet, and Serial
IC12D2A5AWS	IC12M2A5AWS	220 V AC USA	8	Interbus-S, Ethernet, and Serial
IC12D1A5BWS	IC12M1A5BWS	115 V AC USA	8	Interbus-S, Ethernet, and Serial
IC12D2A5BWS	IC12M2A5BWS	220 V AC USA	8	Interbus-S, Ethernet, and Serial
IC12D3A5BWS	IC12M2A5BWS	230 V AC Europe	8	Interbus-S, Ethernet, and Serial
IC12D1A6AWS	IC12M1A6AWS	115 V AC USA	8	EtherNet/IP, Modbus-TCP, Ethernet, and Serial
IC12D2A6AWS	IC12M2A6AWS	220 V AC USA	8	EtherNet/IP, Modbus-TCP, Ethernet, and Serial
IC12D1A6BWS	IC12M1A6BWS	115 V AC USA	8	EtherNet/IP, Modbus-TCP, Ethernet, and Serial
IC12D2A6BWS	IC12M2A6BWS	220 V AC USA	8	EtherNet/IP, Modbus-TCP, Ethernet, and Serial
IC12D3A6BWS	IC12M2A6BWS	230 V AC Europe	8	EtherNet/IP, Modbus-TCP, Ethernet, and Serial
IC12D1B1AWS	IC12M1B1AWS	115 V AC USA	24	Ethernet and Serial
IC12D2B1AWS	IC12M2B1AWS	220 V AC USA	24	Ethernet and Serial
IC12D1B1BWS	IC12M1B1BWS	115 V AC USA	24	Ethernet and Serial
IC12D2B1BWS	IC12M2B1BWS	220 V AC USA	24	Ethernet and Serial
IC12D3B1BWS	IC12M2B1BWS	230 V AC Europe	24	Ethernet and Serial
IC12D1B3AWS	IC12M1B3AWS	115 V AC USA	24	PROFIBUS, Ethernet, and Serial
IC12D2B3AWS	IC12M2B3AWS	220 V AC USA	24	PROFIBUS, Ethernet, and Serial
IC12D1B3BWS	IC12M1B3BWS	115 V AC USA	24	PROFIBUS, Ethernet, and Serial
IC12D2B3BWS	IC12M2B3BWS	220 V AC USA	24	PROFIBUS, Ethernet, and Serial
IC12D3B3BWS	IC12M2B3BWS	230 V AC Europe	24	PROFIBUS, Ethernet, and Serial
IC12D1B4AWS	IC12M1B4AWS	115 V AC USA	24	DeviceNet, Ethernet, and Serial
IC12D2B4AWS	IC12M2B4AWS	220 V AC USA	24	DeviceNet, Ethernet, and Serial
IC12D1B4BWS	IC12M1B4BWS	115 V AC USA	24	DeviceNet, Ethernet, and Serial
IC12D2B4BWS	IC12M2B4BWS	220 V AC USA	24	DeviceNet, Ethernet, and Serial
IC12D3B4BWS	IC12M2B4BWS	230 V AC Europe	24	DeviceNet, Ethernet, and Serial
IC12D1B5AWS	IC12M1B5AWS	115 V AC USA	24	Interbus-S, Ethernet, and Serial
IC12D2B5AWS	IC12M2B5AWS	220 V AC USA	24	Interbus-S, Ethernet, and Serial
IC12D1B5BWS	IC12M1B5BWS	115 V AC USA	24	Interbus-S, Ethernet, and Serial
IC12D2B5BWS	IC12M2B5BWS	220 V AC USA	24	Interbus-S, Ethernet, and Serial
IC12D3B5BWS	IC12M2B5BWS	230 V AC Europe	24	Interbus-S, Ethernet, and Serial
IC12D1B6AWS	IC12M1B6AWS	115 V AC USA	24	EtherNet/IP, Modbus-TCP, Ethernet, and Serial
IC12D2B6AWS	IC12M2B6AWS	220 V AC USA	24	EtherNet/IP, Modbus-TCP, Ethernet, and Serial
IC12D1B6BWS	IC12M1B6BWS	115 V AC USA	24	EtherNet/IP, Modbus-TCP, Ethernet, and Serial
IC12D2B6BWS	IC12M2B6BWS	220 V AC USA	24	EtherNet/IP, Modbus-TCP, Ethernet, and Serial
IC12D3B6BWS	IC12M2B6BWS	230 V AC Europe	24	EtherNet/IP, Modbus-TCP, Ethernet, and Serial

# DC Electric Controllers

## Insight IC12Display & IC12Module

<b>Measurement Resolution</b>	±0.025% of torque full scale
<b>Torque transducer bridge excitation</b>	±5V DC/GND
<b>Torque transducer zero offset / drift compensation</b>	±0.4% of full scale
<b>Input signal sensitivity</b>	2.0 mV/V
<b>Calibration</b>	Values read from spindle memory Automatic digital correction
<b>Frequency response (torque filter)</b>	Selectable 75 Hz, 150 Hz, 350 Hz, 500 Hz, 750 Hz
<b>Keypad (IC-D only)</b>	Membrane keypad containing 4 hot keys, 4 function keys, numerical keypad and directional keypad
<b>Display</b>	IC-D: 3.5-inch diagonal, 320px by 240px, 8-bit 65K backlit color (QVGA) flat panel display IC-M: 5-character, 7-segment numerical LED display
<b>Parameter sets</b>	256
<b>Number of cycles stored in memory</b>	IC-D: 1,000 IC-M: 200
<b>Communication</b>	Serial RS232, Ethernet, optional Profibus, DeviceNet, Interbus-S, EtherNet / IP, Modbus - TCP
<b>I/O</b>	8 inputs / 8 outputs, with behavior assignable through ISC software: with optional I/O card, an additional 16 inputs and outputs are available
<b>Indicators</b>	Power ON lamp
<b>Input voltage</b>	Single-phase 120 volts, 50/60 Hz, 16 amps Single-phase 230 volts, 50/60 Hz, 8 amps
<b>Ambient operating conditions</b>	0 – 50° C, 20/90% non-condensing humidity
<b>Enclosure</b>	IP-52
<b>System weight</b>	5.6 kg (12.4 lb)
<b>Dimensions (mm)</b>	152 h x 191 w x 238d

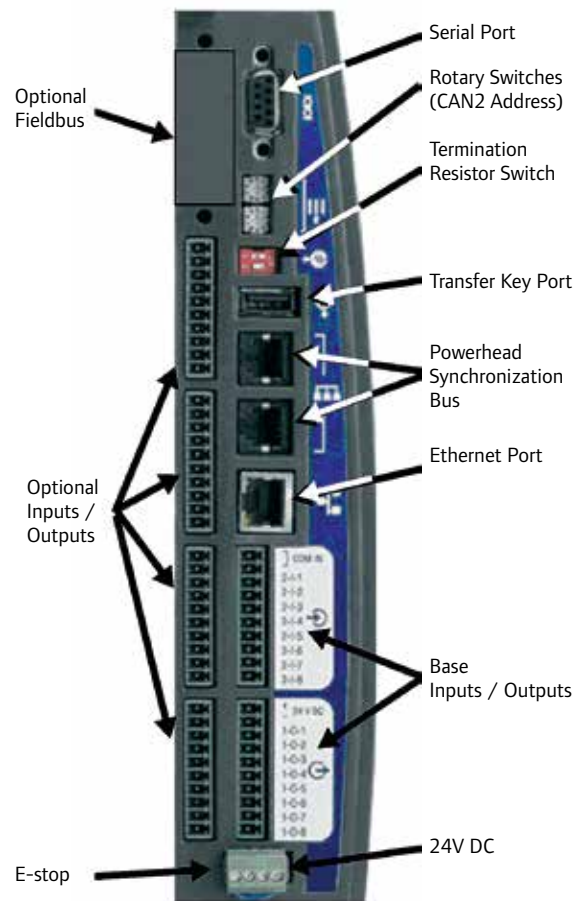



# ICS Software

Paired with an Insight IC12D or IC12M controller and a computer, our ground-breaking ICS Software Suite makes it possible to more precisely control and monitor your fastening process. Optimizing your system is as simple as selecting one of four packages. Visibility of real-time data and controller status can be viewed from your desk top or other remote locations connected to your network. Additional specific information on each software package can be found on the following pages. Software is available in the following languages: Chinese, English, French, German, Italian, Russian and Spanish.

## ICS Connect

ICS Connect gives operators the ability to access and program basic fastening strategies, as well as view cycle data with a single IC12D or IC12M controller via a one-to-one Ethernet connection. ICS Connect is supplied standard with all IC12D and IC12M controllers.



Catalog Reference  
ICS Connect

## ICS Network

Description	Part Number	Spindles
ICS Network enables programming of multiple IC12D and IC12M controllers connected through a local area network (LAN) or direct connection. This option also allows operators to program advanced fastening strategies including yield and prevailing torque control. Finally, ICS Network unlocks the patented TactAlert feature of the QE Series tools that provides the operator with tactile feedback of a tool fault or NOK signal through gentle mechanical oscillation in the grip surface, reducing reliance on visual or audible signals	ICS-NETWORK-001	1
	ICS-NETWORK-002	2
	ICS-NETWORK-005	5
	ICS-NETWORK-010	10
	ICS-NETWORK-020	20
	ICS-NETWORK-050	50
	ICS-NETWORK-100	100
	ICS-NETWORK-500	500

## ICS MultiSync

Description	Part Number	Spindles
The ICS MultiSync package facilitates set-up and control of multiple spindle systems consisting of up to 100 spindles in groups of up to 40 spindles. This package also offers advanced multiple spindle fastening strategies such as fault back-out. Remote monitoring and data archiving are also standard features in this versatile package.	ICS-MULTISYNC-001	1
	ICS-MULTISYNC-002	2
	ICS-MULTISYNC-005	5
	ICS-MULTISYNC-010	10
	ICS-MULTISYNC-020	20
	ICS-MULTISYNC-050	50
	ICS-MULTISYNC-100	100

## ICS Enterprise

Description	Part Number	Spindles
ICS Enterprise offers advanced programming and management of a network of up to 500 IC12D or IC12M controllers using QE tools, QM spindles, or multiple spindle systems. This package includes all elements of ICS Connect, Network, and MultiSync, and also enables ODBC-compliant database archiving, searching, and statistics processing.	ICS-ENTERPRISE-001	1
	ICS-ENTERPRISE-002	2
	ICS-ENTERPRISE-005	5
	ICS-ENTERPRISE-010	10
	ICS-ENTERPRISE-020	20
	ICS-ENTERPRISE-050	50
	ICS-ENTERPRISE-100	100
	ICS-ENTERPRISE-500	500

Additional versions of software have been developed to meet specific customer requirements and protocols.

# ICS Software

Ingersoll Rand offers two levels of controllers and four levels of software. The IC12M controller can only be programmed via one of the software packages. The IC12D controller offers limited basic programming via the keypad. Either controller can be combined with any of the four ICS software packages to provide the features and level of sophistication required for various applications. The ICS Connect program is included standard with each controller. ICS site software is licensed based on the number of controllers to be connected to the network.

	IC12M Controller	IC12D Controller	ICS Connect	ICS Network	ICS MultiSync	ICS Enterprise
<b>SOFTWARE PROGRAMMING</b>						
Maximum Number of Configurations	256	256	256	256	256	256
Maximum Number of Steps per Configuration	32	32	1	32	32	32
Program Parameters: Editable		▲	▲	▲	▲	▲
Gang Count		▲	▲	▲	▲	▲
Auto Increment		▲	▲	▲	▲	▲
Quick Setup		▲	▲	▲	▲	▲
Advanced Setup				▲	▲	▲
Name Configuration			▲	▲	▲	▲
CW/CCW Tightening		▲	▲	▲	▲	▲
Tubenut Operation				▲	▲	▲
Adjustable Acceleration				▲	▲	▲
Optional End of Run Data for Each Step				▲	▲	▲
<b>DATA ARCHIVING</b>						
Number of Stored End of Run Records	200	1000	▲ Unlimited	▲ Unlimited	▲ Unlimited	▲ Unlimited
Data Can be Transferred to					MS SQL	MS SQL
<b>POWERHEAD</b>						
Powerhead Operation					▲	▲
Maximum Number of Spindles in Powerhead					40	40
Maximum Number of Groups					8	8
Fault Backout Options: None, Spindle, Group, Powerhead					▲	▲
Final Fault Backout Options: None, Spindle, Group, Powerhead					▲	▲
Synchronizing Spindles					▲	▲
<b>SOFTWARE GENERAL</b>						
Date/Time Set		▲	▲	▲	▲	▲
System Name			▲	▲	▲	▲
Select Language		▲	▲	▲	▲	▲
Network Time Protocol		▲	▲	▲	▲	▲
End of Run Onscreen Filter			▲	▲	▲	▲
End of Run Viewable on Screen	Value Only	▲	▲	▲	▲	▲
Load New Software via Ethernet	▲	▲	▲	▲	▲	▲

# ICS Software

	IC12M Controller	IC12D Controller	ICS Connect	ICS Network	ICS MultiSync	ICS Enterprise
<b>TOOL PROGRAMMING</b>						
Transducer Value Adjustment		▲	▲	▲	▲	▲
Angle Scaling Constant Adjustment		▲	▲	▲	▲	▲
Transducer and ASC Reset		▲	▲	▲	▲	▲
Auto Calibration Function			▲	▲	▲	▲
Torque Units Selection		▲	▲	▲	▲	▲
Select Start Mode		▲	▲	▲	▲	▲
Tool Operation Selection		▲	▲	▲	▲	▲
Tool Operation Selection		▲	▲	▲	▲	▲
Configuration Mode Selection		▲	▲	▲	▲	▲
Set Preventive Maintenance Alarms				▲	▲	▲
View Tool Memory			▲	▲	▲	▲
<b>PASSWORDS</b>						
Number of Passwords	0	1	Unlimited	Unlimited	Unlimited	Unlimited
Auto Timer Lockout		▲			MS SQL	MS SQL
					▲	▲
<b>STATISTICS</b>						
Sample and Population Statistics		▲	▲	▲	▲	▲
Statistics Values Calculated	Cp, Cpk, Pp, Ppk Mean, SD, Capability, CAM, Max Value, Min Value, % Number of Rejects, % Number of Pass, Number of Rejects High, Number of Rejects Low, Mean Shift, Range					
Statistics Alarms			▲	▲	▲	▲
Statistics Alarms Output	▲	▲	▲	▲	▲	▲
Maximum Sample Statistics Size	200	1000	1000	1000	1000	1000
Powerhead Statistics					▲	▲
Mean Range Charts				▲	▲	▲
Histograms				▲	▲	▲
Pareto Chart				▲	▲	▲
Statistics E-mail Alarms					▲	▲
Stats Calculation from User Selected Data				▲	▲	▲
<b>TIGHTENING CURVES</b>						
Curve Types	Torque vs Angle, Torque vs Time, Current vs Time					
Curve Stored on Controller	Last Reject Last Cycle	Last Reject Last Cycle				
Display Curves On Screen				▲	▲	▲
Print Tightening Curves				▲	▲	▲
Print Tightening Curve Data				▲	▲	▲
Full View				▲	▲	▲
Zoom Function				▲	▲	▲
Number of Curves that Can be Overlaid				1	10	10
Archive Curves					▲	▲
Parameter Values Shown on Curve				▲	▲	▲

# ICS Software

	IC12M Controller	IC12D Controller	ICS Connect	ICS Network	ICS MultiSync	ICS Enterprise
<b>TIGHTENING STRATEGIES</b>						
Torque Control		▲	▲	▲	▲	▲
Torque Control with Angle Monitoring				▲	▲	▲
Torque Control with Yield Override				▲	▲	▲
Angle Control		▲	▲	▲	▲	▲
Angle Control with Torque Monitoring				▲	▲	▲
Angle Control with Yield Override				▲	▲	▲
Yield Control				▲	▲	▲
Drag Torque				▲	▲	▲
Backout				▲	▲	▲
Fault Backout					▲	▲
Final Fault Backout					▲	▲
Retorque				▲	▲	▲
Wait				▲	▲	▲
Jog				▲	▲	▲
Bypass				▲	▲	▲
<b>COMMUNICATION PROTOCOL</b>						
Serial End of Run Data Out		▲	▲	▲	▲	▲
Serial Custom End of Run Data			▲	▲	▲	▲
Host Data Out		▲	▲	▲	▲	▲
PFCS				▲	▲	▲
Plus				▲		▲
Barcode Passive				▲	▲	▲
Open Protocol				▲		▲
XML				▲		▲
PQD				▲		▲
Q-DAS				▲		▲
PLUS				▲		▲
Barcode Active				▲	▲	▲
Barcode Setup on Screen				▲	▲	▲
Field Bus Setup on Screen				▲	▲	▲
Ethernet End of Run Setup				▲	▲	▲
Ethernet End of Run				▲	▲	▲
Ethernet Programming				▲	▲	▲
<b>DIAGNOSTICS</b>						
Error Codes	▲					
Text Codes			▲	▲	▲	▲
System Test		▲	▲	▲	▲	▲
Store System Test Results			▲	▲	▲	▲
View Input Status		▲	▲	▲	▲	▲
Set Output Status		▲	▲	▲	▲	▲
View Outputs		▲	▲	▲	▲	▲
Assign Inputs			▲	▲	▲	▲
Assign Outputs			▲	▲	▲	▲
Event Log			▲	▲	▲	▲
View Event Log			▲	▲	▲	▲
Tool Test		▲	▲	▲	▲	▲
Lamp Test		▲	▲	▲	▲	▲
<b>HELP</b>						
Help Screen Menu			▲	▲	▲	▲
Wizard Text		▲				
<b>PRINT REPORTS</b>						
Number of Reports	0	0	6	6	9	11
Report Types	Cycle Log, Stats, Parameter Dump, Diagnostics, Event Log, Tightening Curve				Histogram, Pareto, Mean/Range	Histogram, Pareto, Mean/Range VIN, Custom
Export to File Function			▲	▲	▲	▲

# DC Electric

## Accessories

### Standard and Extension Cables Cable accessories

Part Number	Description
GEA40-CORD-3M	3 m Standard Cable
CEA40-CORD-6M	6 m Standard Cable
GEA40-CORD-10M	10 m Standard Cable
GEA40-CORD-3M-90	3 m 90 Degree Cable
GEA40-CORD-6M-90	6 m 90 Degree Cable
GEA40-CORD-10M-90	10 m 90 Degree Cable
GEA40-EXT-10M	10 m Extension Cable
GEA40-EXT-20M	20 m Extension Cable
GEA40-EXT-40M	40 m Extension Cable
GEA40-INT-01	50" 90 Degree Extension Cable
GEA40-INT-02	60" 90 Degree Extension Cable
GEA40-INT-03	70" 90 Degree Extension Cable
GEA40-INT-04	80" 90 Degree Extension Cable
GEA40-INT-05	90" 90 Degree Extension Cable
GEA40-INT-06	100" 90 Degree Extension Cable
GEA40-INT-07	110" 90 Degree Extension Cable
GEA40-INT-08	120" 90 Degree Extension Cable
GEA40-INT-09	130" 90 Degree Extension Cable

Handle Module Extension Cables	(2m)	(4m)	(6m)
Handle extension cord set	QMMC-46-2M	QMMC-46-4M	QMMC-46-6M
Interface Module Cables			
Interface extension cable (10 m)			QMMC-A240-10
Interface extension cable (20 m)			QMMC-A240-20
Power cable (2 m)			QMMC-A240-2
DC Tool Cables	(3m)	(6m)	(10m)
Tool cable (QE2)	CPS2-CORD-3M	CPS2-CORD-6M	CPS2-CORD-10M
90° tool cable (QE2)	—	CPS2-CORD-6M-90	—
Tool cable (QM, QE4/6/8)	CEA40-CORD-3M	CEA40-CORD-6M	CEA40-CORD-10M
90° tool cable (QM, QE4/6/8)	CEA40-CORD-3M-90	CEA40-CORD-6M-90	CEA40-CORD-10M-90



Standard Cable



90 Degree Cable

### Lever Kits

Part Number	Description
GEA40-K98SL	Short Lever Kit
GEA40-K98EL	Extended Lever Kit

### Hanging and Mounting Accessories

Part Number	Description	For Use With
GEA15-K364	Swivel Hanger Kit	QE4
GEA40-K364	Swivel Hanger Kit	QE6 & QE8
7L-365	Suspension Bail	All QE Series
CPS2-K48	Reaction Bar Kit	QE2
GEA15-K48	Reaction Bar Kit	QE4, QA4 inline up to 27 Nm
GEPTS15-K48	Reaction Bar Kit	QE4TS
DEA120-K48	Reaction Bar Kit	QE6 & QE8, QA4 inline 46 Nm
15E4-K48	Flanged Mounting Kit	QE4, QA4 / QA8 inline up to 55 Nm, 90 Nm, angle 115 / 150 Nm
GEM120-K48	Flanged Mounting Kit	QE6 & QE8, QA6 / QA8 inline 70 / 90 Nm, angle 115 / 150 Nm
GEA4-K48	Mounting Plate Kit	QE4, QA6 / QA8 inline up to 55 Nm, angle up to 90 Nm
DAM120-K48	Mounting Plate Kit	QE6 & QE8, QA6 / QA8 inline 70 / 90 Nm, angle 115 / 150 Nm



Flange Mounting Kit



Mounting Plate Kit



Swivel Hanger Kit

# DC Electric

## Accessories

### Socket Trays and Accessories

Part Number	Description
IC-BIT-8	Bit selector tray
IC-SOCKET-4	4-position socket tray
IC-SOCKET-8	8-position socket tray
IC-10PIN-6M	6 m cable for 4-position tray
IC-10PIN-10M	10 m cable for 4-position tray
IC-19PIN-5M	5 m cable for 8-position tray
IC-19PIN-10M	10 m cable for 8-position tray
GEA15-38KIT-5	3/8" socket pin kit
GEA40-12KIT-5	1/2" socket pin kit
PC80150113	Controller Transfer Key



4-Position Socket Tray



Bit Selector Tray

### Other Accessories

#### Angle Head Boots

25 mm	28 mm	35 mm	43 mm	48 mm	56 mm
131996	131995	131997	GEA40-172	GEA40-173	GEA240-173

Based on tool angle head diameter



# Pistol Grip Pulse Tools

Transducerized

## QXP Series

Combine the power and ergonomics of the latest generation of reactionless pulse tools with closed-loop electronic control to maximize productivity in torque-critical applications.

### Features

- Torque range: 7.4 – 162 ft-lbs (10 – 220 Nm)
- Speeds: 4,200 – 7,000 rpm
- Extremely compact, lightweight, ergonomic design
- World-class power-to-weight ratio
- Reactionless, high-speed operation
- Accurate, adjustable closed-loop torque control
- Low noise and vibration
- Visible and audible feedback
- Recommended for applications requiring data output, closed-loop torque accuracy, process control, and operator feedback



QXP110P8

### Service and Accessories

#### Manuals:

80206642

80194574

80206675

#### Accessories:

Impact sockets, see form # IR-0506-016

Spring balancers, see page 86

Model		 ft-lbs (Nm)	 1 min. rpm	 lbs (kg)	 in (mm)	 in (mm)	 cfm	 in
<b>DC TRIGGER START</b>								
QXP60P6	M6	7.4 – 14.5 (10 – 19.5)	6,000	2.8 (1.26)	7.0" (179)	0.8" (21)	9.5	3/8"
QXP60Q4	M6	6.3 – 11.8 (8 – 16)	6,000	2.8 (1.26)	7.0" (179)	0.8" (21)	9.5	1/4"
QXP70P6	M6 – M8	13 – 24 (18 – 33)	7,000	2.8 (1.26)	7.0" (179)	0.8" (21)	11.3	3/8"
QXP70Q4	M6 – M8	11 – 20 (15 – 27)	7,000	2.8 (1.26)	7.0" (179)	0.8" (21)	11.3	1/4"
QXP80P6	M8	17 – 33 (24 – 46)	7,000	3.0 (1.3)	7.3" (186)	0.8" (21)	11.3	3/8"
QXP90P6	M8 – M10	26 – 44 (35 – 60)	6,500	3.3 (1.50)	7.7" (195)	0.9" (23)	14.5	3/8"
QXP110P8	M10 – M12	35 – 70 (48 – 95)	5,500	4.1 (1.86)	8.2" (209)	1.0" (25.6)	18.7	1/2"
QXP120P8	M12	48 – 92 (65 – 125)	5,900	5.4 (2.46)	8.8" (223)	1.1" (29)	21.2	1/2"
QXP140P8	M14	55 – 114 (75 – 155)	5,200	6.3 (2.86)	9.3" (235)	1.1" (29)	27.7	1/2"
QXP150P8	M16	81 – 162 (110 – 220)	4,200	7.5 (3.41)	9.6" (241)	1.3" (32.5)	27.9	1/2"
<b>DC TRIGGER START (ANGLE ENCODED)</b>								
QXP600Q4	M6	6.3 – 11.8 (8 – 16)	6,000	2.9 (1.34)	7.4" (189)	0.8" (21)	9.5	1/4"
QXP600P6	M6	7.4 – 14.5 (10 – 19.5)	6,000	2.9 (1.34)	7.4" (189)	0.8" (21)	9.5	3/8"
QXP700Q4	M6 – M8	11 – 20 (15 – 27)	7,000	2.9 (1.34)	7.4" (189)	0.8" (21)	11.3	1/4"
QXP700P6	M6 – M8	13 – 24 (18 – 33)	7,000	2.9 (1.34)	7.4" (189)	0.8" (21)	11.3	3/8"
QXP900P6	M8 – M10	26 – 44 (35 – 60)	6,500	3.3 (1.5)	8.1 (204)	0.9" (23)	14.5	3/8"
QXP1100P8	M10 – M12	35 – 70 (48 – 95)	5,500	4.3 (1.97)	8.7" (220)	1" (25.5)	18.7	1/2"
QXP1400P8	M14	55 – 114 (75 – 155)	5,200	6.6 (3)	9.7" (246)	1.1" (29)	27.7	1/2"

Series			
QXP	75 – 87 dBA	1/4" NPT	3/8" (10 mm)

# Pistol Grip Pulse Tools

Transducerized

## YE Classic Series

Combine the power and ergonomics of reactionless pulse tools with closed-loop electronic control to maximize productivity in torque-critical applications.



### Features

- Torque range: 2.8 – 227 ft-lbs (3.9 – 310 Nm)
- Speeds: 2,300 – 9,000 rpm
- Excellent power-to-weight ratio
- Reactionless, high-speed operation
- Accurate, adjustable closed-loop torque control
- Low noise and vibration
- Recommended for applications requiring data output, closed-loop torque accuracy, process control, and operator feedback

### Service and Accessories

#### Manuals:

P7584

P7371

#### Accessories:

Impact sockets, see form # IR-0506-016

Spring balancers

Model		ft-lbs (Nm)	1 min. rpm	lbs (kg)	in (mm)	in (mm)	cfm	in
<b>DC TRIGGER START</b>								
YEX-120A	M5 – M6	2.8 – 5.6 (3.9 – 7.7)	7,000	3.2 (1.43)	8.8" (223)	0.93" (23.5)	8.8	1/4"
YEX-120	M5 – M6	3.2 – 6.3 (4.4 – 8.6)	7,000	3.2 (1.43)	8.7" (222)	0.93" (23.5)	8.8	3/8"
YEX-150A	M5 – M6	4 – 9 (5.8 – 13)	9,000	3.2 (1.43)	8.8" (223)	0.91" (23.0)	10.6	1/4"
YEX-150	M5 – M6	5 – 11 (7.3 – 16)	9,000	3.2 (1.43)	8.7" (222)	0.91" (23.0)	10.6	3/8"
YEX-501A	M6 – M8	12 – 29 (17 – 40)	8,200	4.4 (2.0)	8.9" (227)	1.04" (26.5)	12.4	1/4"
YEX-501	M6 – M8	14 – 42 (20 – 44)	8,200	4.4 (2.0)	9.4" (234)	1.04" (26.5)	12.4	3/8"
YEX-701	M8 – M10	18 – 45 (27 – 62)	8,000	4.9 (2.2)	9.7" (246)	1.04" (26.5)	13.4	3/8"
YEX-901	M10	26 – 57 (36 – 78)	6,100	5.9 (2.7)	10.1" (257)	1.32" (33.5)	17.7	1/2"
YEX-1400	M10 – M12	42 – 86 (58 – 118)	5,900	7.7 (3.5)	10.5" (266)	1.34" (34.0)	23.3	1/2"
YEX-1900	M12	50 – 100 (65 – 137)	5,800	9.0 (4.1)	10.9" (277)	1.54" (39.0)	23.3	1/2"
YEX-3000	M16	100 – 172 (137 – 235)	4,000	14.1 (6.4)	12.2" (309)	1.57" (40.0)	25.8	3/4"
YED-200	M18 – M20	126 – 227 (170 – 310)	2,300	15.0 (6.8)	12.0" (307)	1.60" (40.0)	38.9	3/4"

Series			
YEX	74 – 80 dBA	1/4" NPT	3/8" (10 mm)
YED	86 dBA	1/2" NPT	1/2" (13 mm)



# Inline Pulse Tools

Transducerized

## YE Classic Series

Combine the power and ergonomics of reactionless pulse tools with closed-loop electronic control to maximize productivity in torque-critical applications.



### Features

- Torque range: 2.7 – 45 ft-lbs (3.6 – 61 Nm)
- Speeds: 7,500 – 10,000 rpm
- Excellent power-to-weight ratio
- Reactionless, high-speed operation
- Accurate, adjustable closed-loop torque control
- Low noise and vibration
- Recommended for applications requiring data output, closed-loop torque accuracy, process control, and operator feedback

### Service and Accessories

#### Manuals:

P7371

#### Accessories:

Sockets, see form # IR-0506-016  
Spring balancers

Model		ft-lbs (Nm)	1 min. rpm	lbs (kg)	in (mm)	in (mm)	cfm	in
<b>DC TRIGGER START</b>								
YEX-120SA	M5 – M6	3 – 5.6 (4 – 7.7)	10,000	2.6 (1.18)	10.5" (267)	1.22" (31.0)	8.8	1/4"
YEX-120S	M5 – M6	3.2 – 6.3 (4.4 – 8.6)	10,000	2.6 (1.18)	10.5" (267)	1.22" (31.0)	8.8	3/8"
YEX-150SA	M5 – M6	4.2 – 9.5 (5.8 – 13)	9,000	3.0 (1.43)	10.9" (276)	0.91" (23.0)	10.6	1/4"
YEX-150S	M5 – M6	5.3 – 11.7 (7.3 – 16)	9,000	3.2 (1.45)	10.8" (275)	0.91" (23.0)	10.6	3/8"
YEX-300SA	M6	6.4 – 13.2 (8.7 – 18)	8,000	4.0 (1.80)	12.3" (313)	1.06" (27.0)	11	1/4"
YEX-300S	M6	7 – 14.5 (9.7 – 20)	8,000	4.0 (1.80)	12.3" (313)	1.06" (27.0)	11	3/8"
YEX-500SA	M6 – M8	9.6 – 22 (13.1 – 31)	7,800	4.6 (2.10)	13.2" (334)	1.06" (27.0)	11.7	1/4"
YEX-500S	M6 – M8	11 – 25 (14.7 – 34)	7,800	4.6 (2.10)	13.1" (333)	1.06" (27.0)	11.7	3/8"
YEX-700S	M8	16.5 – 37 (22.5 – 51)	7,500	5.1 (2.30)	13.1" (333)	1.06" (27.0)	13.1	3/8"

Series			
YEX	74 – 80 dBA	1/4" NPT	3/8" (10 mm)

# Controllers

## YETC-210 Series

Combine the power and ergonomics of reactionless pulse tools with closed-loop electronic control to maximize productivity in torque-critical applications.

### Features

- Easy setup and programming of up to 8 parameter groups
- Closed-loop torque control for QXP and YE Series tools
- Torque readout and data output
- Detects rehits, cross-threads, and early throttle release
- Cycle and batch OK/NOK signals
- I/O for process flow control
- Advanced tightening strategies available
- Recommended for applications requiring data output, closed-loop torque accuracy, process control, and operator feedback

### Programmable parameters:

- Maximum torque
- Minimum torque
- Target torque
- Threshold torque
- Tool coefficient
- Fast error (pre-tightened)
- Slow error (cross thread)
- Gang control
- Additional advanced parameters



### Additional Equipment

#### Standard equipment:

3/8" (10 mm)	
Controller	
10-meter tool cable	Y-7642-0908-0117
Solenoid valve	
Tool air hose with quick couplers	
Air regulator	

#### Optional equipment:

15-meter tool cable	Y-7642-0908-0119
20-meter extension tool cable	Y-7642-0908-0122
3/8" solenoid valve	Y-9191-1026-0000
1/2" solenoid valve	YETV-12KIT
Printer	Y-CTZ

#### Manuals:

- P7395
- P7396

Model	in (mm)	in (mm)	in (mm)	lbs (kg)	Volts	Configs	Angle
YETC-210ETB	9" (230)	4.3" (110)	11.4" (290)	11.4 (5.2)	117 V AC	8	No
YETC-210ETF*	9" (230)	4.3" (110)	11.4" (290)	11.4 (5.2)	117 V AC	4 x 2	No
YETC-210ETR	9" (230)	4.3" (110)	11.4" (290)	11.4 (5.2)	117 V AC	8	Yes
YETC-210R-L†	9" (230)	4.3" (110)	11.4" (290)	11.4 (5.2)	117 V AC	8	Yes

\* Supports two tools † Ethernet ready

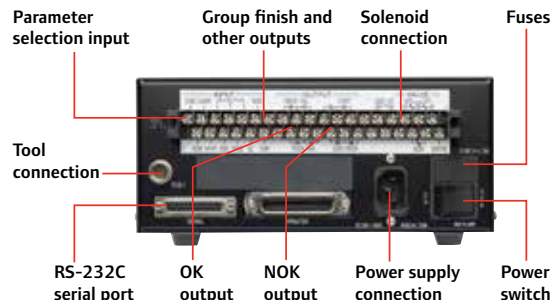
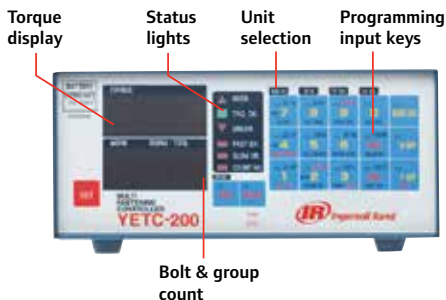

# Calibration Equipment

## EXTA Series – Expert Torque Analyzer

### Features

- Lightweight portable unit
- Compatible with full range of Industry Standard (IS) and Smart external transducers
- Large LCD screen
- Full keypad and easy-to-navigate menus
- Full statistical capabilities
- Rechargeable battery with auto-shutdown feature



### Manuals:

- 45652906 EXT Series
- 45655859
- 45654696

Model	Description	Units of Measure	Data Analysis	Number of Configurations	Languages	Recording Models
EXTA	Expert Torque Analyzer	9	Cp, Cpk, Pp, Ppk, CMK, CAM, Range, Mean, Standard Deviation	250	English, German, French, Italian, Spanish	peak, click pulse, track

### Accessories

Transducers					
Industry Standard	Smart Transducers				
	Torque only	Torque and Angle	(in-lb) ft-lb	N-m	in
<b>ROTARY</b>					
TR2H4	-	-	(1.0 - 18)	0.10 - 2	1/4" ⌀
TR5H4	TRD5H4	TRDA5H4	(2.2 - 44)	0.25 - 5	1/4" ⌀
TR20H4	TRD20H4	TRDA20H4	(9.0 - 180)	1 - 20	1/4" ⌀
TR20S4	TRD20S4	TRDA20S4	(9.0 - 180)	1 - 20	1/4" □
TR75S6	TRD75S6	TRDA75S6	2.8 - 55	3.8 - 75	3/8" □
TR180S8	TRD180S8	TRDA180S8	6.7 - 133	9 - 180	1/2" □
TR250S12	-	-	9.2 - 185	12.5 - 250	3/4" □
TR500S12	TRD500S12	TRDA500S12	18.5 - 370	25 - 500	3/4" □
<b>STATIONARY</b>					
TS30S4	TSD28S4	-	1.1 - 22	1.5 - 30	1/4"
TS150S6	TSD135S6	-	5.5 - 110	7.5 - 150	3/8"
TS300S8	TSD270S8	-	11 - 221	15 - 300	1/2"
TS1000S12	TSD1000S12	-	37 - 738	50 - 1000	3/4"



Stationary transducer with joint simulator

Joint Simulators					
Model	Includes Transducer	Joint Simulator Bolt Service Kit			
			ft-lb	Nm	in
<b>ROTARY</b>					
JKR20	No	JKS30-BKIT	0.75 - 15	1.0 - 20	1/4"
JKR75	No	JKS150-BKIT	2.8 - 55	3.8 - 75	3/8"
JKR180	No	JKS300-BKIT	6.7 - 133	9.0 - 180	1/2"
JKR500	No	JKS1000-BKIT	18.5 - 370	25.0 - 500	3/4"
<b>STATIONARY</b>					
JKS30	No	JKS30-BKIT	1.1 - 22	1.5 - 30	1/4"
JKS150	No	JKS150-BKIT	5.5 - 110	7.5 - 150	3/8"
JKS300	No	JKS300-BKIT	11.0 - 221	15.0 - 300	1/2"
JKS1000	No	JKS1000-BKIT	37.0 - 738	50.0 - 1000	3/4"
JKST30	TS30S4	JKS30-BKIT	1.1 - 22	1.5 - 30	1/4"
JKST150	TS150S6	JKS150-BKIT	5.5 - 110	7.5 - 150	3/8"
JKST300	TS300S8	JKS300-BKIT	11.0 - 221	15.0 - 300	1/2"
JKST1000	TS1000S12	JKS1000-BKIT	37.0 - 738	50.0 - 1000	3/4"



Rotary transducers

# Calibration Equipment



## EXTT Series – Expert Torque Testers

### Features

- Monitors torque, angle, time, and pulse count
- Reads in peak, click, pulse, or track mode
- Stores 200 time-stamped readings
- Auto-recognition of Smart transducers
- Seven units of measure
- Selectable filter frequencies
- DC tool calibration via ICS software
- Selectable power-save settings
- Selectable languages include English, French, German, Italian, and Spanish



### Manuals:

-  45652906    EXT T Series
-  45655859
-  45654696

EXTT SERIES — EXPERT TORQUE TESTERS				
				
Model	in-lb	Nm	Rundown Adapter*	Rundown Adapter Service Kit
EXTT-1	0.88 – 8.8	0.1 – 1	ETT-RA-1	ETT-RA-1-KIT
EXTT-4	3.50 – 35	0.4 – 4	ETT-RA-4	ETT-RA-4-KIT
EXTT-12	10.6 – 106	1.2 – 12	ETT-RA-12	ETT-RA-12-KIT
EXTT-30	26.5 – 265	3.0 – 30	ETT-RA-30	ETT-RA-30-KIT

\* EXT T tester includes rundown adapter, carrying case, battery charger, manuals, and a certificate of calibration. EXT A analyzer includes carrying case, battery charger, manuals, and neck strap.

# Calibration Equipment

## Rotary Transducers







### Rotary Transducers:

- Industry-standard – works with ETA analyzers and other equipment that utilizes industry-standard transducers
- ETA2-TC “Smart” Series – the range and calibration will auto-identify when working with the ETA2-TC analyzer (available in Torque and Torque/Angle models)



### Manuals:

 7464



Industry Standard		ETA-2-TC Series “Smart” Transducers			
Torque	Torque & Angle	rpm	lbs (kg)	in-lbs (Nm)	in
<b>ROTARY TRANSDUCERS</b>					
TR750S16	TRA750S16	TRD750S16	TRDA750S16	(750)	1” 
TR1400S16	TRA1400S16	TRD1400S16	TRDA1400S16	(1400)	1” 
TR3000S24	TRA3000S24	TRD3000S24	TRDA3000S24	(3000)	1½” 
TR5000S24	—	—	—	(5000)	1½” 

\*Industry-standard transducers require ETA2-TC cable.

<b>Joint Simulators</b>					
Model	Includes Transducer	Joint Simulator Bolt Service Kit			
			ft-lb	Nm	in
<b>ROTARY</b>					
JKR20	No	JKS30-BKIT	0.75 - 15	1.0 - 20	1/4”
JKR75	No	JKS150-BKIT	2.8 - 55	3.8 - 75	3/8”
JKR180	No	JKS300-BKIT	6.7 - 133	9.0 - 180	1/2”
JKR500	No	JKS1000-BKIT	18.5 - 370	25.0 - 500	3/4”
<b>STATIONARY</b>					
JKS30	No	JKS30-BKIT	1.1 - 22	1.5 - 30	1/4”
JKS150	No	JKS150-BKIT	5.5 - 110	7.5 - 150	3/8”
JKS300	No	JKS300-BKIT	11.0 - 221	15.0 - 300	1/2”
JKS1000	No	JKS1000-BKIT	37.0 - 738	50.0 - 1000	3/4”
JKST30	TS30S4	JKS30-BKIT	1.1 - 22	1.5 - 30	1/4”
JKST150	TS150S6	JKS150-BKIT	5.5 - 110	7.5 - 150	3/8”
JKST300	TS300S8	JKS300-BKIT	11.0 - 221	15.0 - 300	1/2”
JKST1000	TS1000S12	JKS1000-BKIT	37.0 - 738	50.0 - 1000	3/4”

## Transducer & Joint Kits











### Rotary Transducers:

- Industry-standard – works with ETA analyzers and other equipment that utilizes industry-standard transducers
- ETA “Smart” Series – the range and calibration will auto-identify when working with the ETA analyzer (available in Torque and Torque/Angle models)

### Manuals:

 7464



Industry Standard	ETA Series “Smart” Transducers			
	rpm	lbs (kg)	in-lbs (Nm)	in
<b>ROTARY TRANSDUCERS</b>				
TR2H4	—	—	1.0 - 18 (0.10 - 2)	1/4” 
TR5H4	TRD5H4	TRDA5H4	2.2 - 44 (0.25 - 5)	1/4” 
TR20H4	TRD20H4	TRDA20H4	9.0 - 180 (1 - 20)	1/4” 
TR20S4	TRD20S4	TRDA20S4	9.0 - 180 (1 - 20)	1/4” 
TR75S6	TRD75S6	TRDA75S6	2.8 - 55 (3.8 - 75)	3/8” 
TR180S8	TRD180S8	TRDA180S8	6.7 - 133 (9 - 180)	1/2” 
TR250S12	—	—	9.2 - 185 (12.5 - 250)	3/4” 
TR500S12	TRD500S12	TRDA500S12	18.5 - 370 (25 - 500)	3/4” 

\*Industry-standard transducers require ETA2-TC cable.

# Calibration Equipment

## Stationary Transducers:







- Industry-standard – works with ETA analyzers and other equipment that utilizes industry-standard transducers
- ETA “Smart” Series – the range and calibration will auto-identify when working with the ETA analyzer

### Manuals:

 7464



Shown with joint kit

Stationary Transducer	ETA Series “Smart” Transducer	 in-lbs (Nm)	 in
<b>STATIONARY TRANSDUCERS</b>			
TS30S4	TSD28S4	1.1 – 22 (1.5 – 30)	1/4" 
TS150S6	TSD135S6	5.5 – 110 (7.5 – 150)	3/8" 
TS300S8	TSD270S8	11 – 221 (15 – 300)	1/2" 
TS1000S12	TSD1000S12	37 – 738 (50 – 1000)	3/4" 

## Transducer & Joint Kits











### Joint Simulators:





- Range up to 1000 Nm
- Rate can be changed to emulate different joint conditions from hard to soft
- Available with or without an industry-standard stationary transducer

### Manuals:

 P7529



Model	Nm	in
<b>STATIONARY TRANSDUCER WITH JOINT SIMULATOR</b>		
JKST30	1.5 – 30	1/4" 
JKST150	7.5 – 135	3/8" 
JKST300	15 – 300	1/2" 
JKST1000	50 – 1000	3/4" 
<b>JOINT SIMULATORS FOR STATIONARY TRANSDUCER</b>		
JKS30	30	1/4" 
JKS150	150	3/8" 
JKS300	300	1/2" 
JKS1000	1000	3/4" 

Model	Nm	in
<b>JOINT SIMULATORS FOR ROTARY TRANSDUCER</b>		
JKR20	20	1/4" 
JKR75	75	3/8" 
JKR180	180	1/2" 
JKR500	500	3/4" 

# Spring Balancers

## Cable

### BLD Series

#### Features

- Self-lubricating bushings
- Adjustable capacity and stroke limiting device
- Auxiliary safety suspension

#### Manuals:

 BLD



BLD1

Model	SWL lbs (kg)	ft (m)	lbs (kg)
<b>BLD SERIES</b>			
BDL 1	0.9 – 2.2 (0.4 – 1.0)	5.2 (1.6)	1.3 (0.6)
BDL 2	2.2 – 4.4 (1.0 – 2.0)	5.2 (1.6)	1.3 (0.6)
BDL 3	4.4 – 6.6 (2.0 – 3.0)	5.2 (1.6)	1.5 (0.7)

### BIDS Series

#### Features

- Safety device prevents dropping of load due to spring breakage
- Anti-friction cable guide
- Adjustable stroke limiting device
- Upper rotary suspension
- Safety hook
- Auxiliary safety suspension

#### Manuals:

 BIDS



BIDS-14





Model	SWL lbs (kg)	ft (m)	lbs (kg)
<b>BIDS SERIES</b>			
BIDS-7	8.8 – 15.4 (4.0 – 7.0)	6.5 (2.0)	5.0 (2.26)
BIDS-10	15.4 – 22.0 (7.0 – 10.0)	6.5 (2.0)	5.5 (2.49)
BIDS-14	22.0 – 30.9 (10.0 – 14.0)	6.5 (2.0)	5.5 (2.49)
BIDS-18	30.9 – 39.7 (14.0 – 18.0)	6.5 (2.0)	6.5 (2.95)
BIDS-22	39.7 – 48.5 (18.0 – 22.0)	6.5 (2.0)	6.5 (2.95)
BIDS-26	48.5 – 55.1 (22.0 – 25.0)	6.5 (2.0)	6.5 (2.95)

### BMD Series

#### Features

- Safety device prevents dropping of load due to spring breakage (except on BMDS-2)
- Anti-friction cable guide
- Adjustable stroke-limiting device

#### Manuals:

 BMDL4     BMDS2  
 BMDLL     BMDS4



BMDS-2

Model	SWL lbs (kg)	ft (m)	lbs (kg)
<b>BMD SERIES</b>			
BMDS-2	2.2 – 5.5 (1.0 – 2.5)	6.5 (2.0)	4.4 (2.0)
BMDS-4	4.4 – 8.8 (2.0 – 4.0)	6.5 (2.0)	4.4 (2.0)
BMDL-4	4.4 – 8.8 (2.0 – 4.0)	8.2 (2.5)	6.4 (2.9)
BMDS-6	8.8 – 13.2 (4.0 – 6.0)	6.5 (2.0)	5.1 (2.3)
BMDL-6	8.8 – 13.2 (4.0 – 6.0)	8.2 (2.5)	7.1 (3.2)
BMDS-8	13.2 – 17.6 (6.0 – 8.0)	6.5 (2.0)	5.5 (2.5)
BMDL-8	13.2 – 17.6 (6.0 – 8.0)	8.2 (2.5)	7.7 (3.5)
BMDL-10	17.6 – 22.0 (8.0 – 10.0)	8.2 (2.5)	8.2 (3.7)
BMDL-12	22.0 – 26.5 (10.0 – 12.0)	8.2 (2.5)	8.8 (4.0)
BMDLL-4 <sup>(1)</sup>	4.4 – 8.8 (2.0 – 4.0)	8.2 (2.5)	6.6 (3.0)
BMDLL-6 <sup>(1)</sup>	8.8 – 13.2 (4.0 – 6.0)	8.2 (2.5)	7.3 (3.3)
BMDLL-8 <sup>(1)</sup>	13.2 – 17.6 (6.0 – 8.0)	8.2 (2.5)	7.9 (3.6)
BMDLL-10 <sup>(1)</sup>	17.6 – 22.0 (8.0 – 10.0)	8.2 (2.5)	8.4 (3.8)

(1) Locking type balancer.

# Spring Balancers

## Cable

### BSD Series



#### Features



- Safety device prevents load dropping
- Upper suspension with rotary safety hook
- Anti-friction cable guide
- Precision-guided cable winding prevents jams
- Worm screw capacity adjustment
- Cable visible for inspection
- Cable replacement without balancer disassembly

#### Manuals:

 BSD



Model	 SWL lbs (kg)	 ft (m)	 lbs (kg)
<b>BSD SERIES</b>			
BSD-20	33.1 – 44.1 (15.0 – 20.0)	8.2 (2.5)	41.9 (19.0)
BSDL-20	33.1 – 44.1 (15.0 – 20.0)	9.85 (3.0)	42.1 (19.1)
BSDL-25	44.1 – 55.1 (20.0 – 25.0)	9.85 (3.0)	43.9 (19.9)
BSD-30	44.1 – 66.1 (20.0 – 30.0)	8.2 (2.5)	43.7 (19.8)
BSDL-35	55.1 – 77.2 (25.0 – 35.0)	9.85 (3.0)	46.1 (20.9)
BSD-40	66.1 – 88.2 (30.0 – 40.0)	8.2 (2.5)	45.9 (20.8)
BSDL-45	77.2 – 99.2 (35.0 – 45.0)	9.85 (3.0)	52.5 (23.8)
BSD-50	88.2 – 110.2 (40.0 – 50.0)	8.2 (2.5)	52.7 (23.9)
BSDL-50	88.2 – 110.2 (40.0 – 50.0)	9.85 (3.0)	52.7 (23.9)
BSD-60	110.2 – 132.3 (50.0 – 60.0)	8.2 (2.5)	56.0 (25.4)
BSDL-60	110.2 – 132.3 (50.0 – 60.0)	9.85 (3.0)	55.8 (25.3)
BSD-70	132.3 – 154.3 (60.0 – 70.0)	8.2 (2.5)	59.1 (26.8)
BSDL-70	132.3 – 154.3 (60.0 – 70.0)	9.85 (3.0)	58.9 (26.7)
BSD-80	154.3 – 176.4 (70.0 – 80.0)	8.2 (2.5)	61.3 (27.8)

Model	 SWL lbs (kg)	 ft (m)	 lbs (kg)
<b>BSD SERIES (CONTINUED)</b>			
BSDL-80	154.3 – 176.4 (70.0 – 80.0)	9.85 (3.0)	61.7 (28.0)
BSD-90	176.4 – 198.4 (80.0 – 90.0)	8.2 (2.5)	63.5 (28.8)
BSDL-90	176.4 – 198.4 (80.0 – 90.0)	9.85 (3.0)	63.9 (29.0)
BSD-100	198.4 – 220.5 (90.0 – 100.0)	8.2 (2.5)	78.5 (35.6)
BSDL-100	198.4 – 220.5 (90.0 – 100.0)	9.85 (3.0)	81.1 (36.8)
BSDL-115	242.5 – 253.5 (110.0 – 115.0)	9.85 (3.0)	85.3 (38.7)
BSD-120	220.5 – 264.6 (100.0 – 120.0)	8.2 (2.5)	85.3 (38.7)
BSDL-130	253.5 – 286.6 (115.0 – 130.0)	9.85 (3.0)	88.0 (39.9)
BSD-140	264.6 – 308.6 (120.0 – 140.0)	8.2 (2.5)	92.2 (41.8)
BSDL-140	286.6 – 308.6 (130.0 – 140.0)	9.85 (3.0)	94.4 (42.8)
BSD-150	286.6 – 330.7 (130.0 – 150.0)	8.2 (2.5)	98.1 (44.5)
BSDL-150	308.6 – 330.7 (140.0 – 150.0)	9.85 (3.0)	100.5 (45.6)
BSD-165	330.7 – 363.8 (150.0 – 165.0)	8.2 (2.5)	106.3 (48.2)
BSDL-80	154.3 – 176.4 (70.0 – 80.0)	8.2 (2.5)	61.3 (27.8)



# Torque Reaction Arms

Bench & Floor Mounted

## QTA Series

Reaction arms that set the standard for ergonomics, ease of use, and durability.

### Features

- Torque capacity range from 10 – 475 Nm (7.4 – 350 ft-lbs)
- Arms up to model QTA150 utilize an Ingersoll Rand die-cast aluminum spring balancer to aid up/down movement
- Floor mounted models QTA270 and QTA475 use Ingersoll Rand air cylinders and regulator to assist in up/down travel
- QTA150 arm can be adjusted to mount to either a bench or the floor
- Anodized aluminum on bench-mounted arms delivers toughness in a lightweight design
- Simple, proven architecture makes for trouble-free set-up and use
- Arms up to QTA100 include a standard inline tool holder
- Cable/air line clips keep work area organized

### Service and Accessories

#### Manuals:

-  45546959
-  45546942
-  45546967

#### Accessories:

- QTA tool holders
- Upper pole clamp and inverse mounting kit available for bench-only models



	Torque Capacity	Weight Capacity	Max Working Reach	Approx. Vertical Travel	Overall Height	Mounting Style	Movement Style
Model	Nm (ft-lbs)	lbs (kg)	in (mm)	in (mm)	in (mm)		
QTA010	10 (7.4)	2.64 (1.20)	15" (381)	13.0" (330)	27.8" (706)	Bench	Spring bal
QTA020	20 (14.8)	5.00 (2.27)	20" (508)	14.5" (368)	31.8" (808)	Bench	Spring bal
QTA040	40 (29.5)	6.50 (2.95)	25" (635)	17.5" (445)	39.7" (1008)	Bench	Spring bal
QTA100	100 (73.8)	8.00 (3.63)	30" (762)	17.5" (445)	39.7" (1008)	Bench	Spring bal
QTA150	150 (110.6)	10.00 (4.54)	52" (1321)	22.0" (559)	78.7" (2000)	Bench/Floor	Spring bal
QTA270	270 (199)	22.00 (10.0)	60" (1524)	18.8" (477)	78.7" (2000)	Floor	Air cylinders
QTA475	475 (350)	50.60 (23.0)	79" (2007)	23.2" (590)	78.7" (2000)	Floor	Air cylinders

## Bench Mounted Arm Accessories

Model	QTA010	QTA0120	QTA040	QTA100
Inverse Mounting Kit	IMK010	IMK020	IMK100	IMK100
Upper Pole Clamp	PUC010	PUC020	PUC100	PUC100

# Tool Holders

## QA/QE Series & Generic Styles

### Holders for QTA Torque Arms

Select from a wide variety of options to ensure that the tool is correctly and safely secured to the torque arm.

#### Features

- Generic holders clamp to the Ingersoll Rand tools or a competitive model
- Threaded tool holder (1/4" NPT) for low-torque air tools
- For Ingersoll Rand QA & QE Series tools, please refer to the chart below to select the proper holder
- QA/QE specific holders can be mounted horizontally or vertically based on your application needs

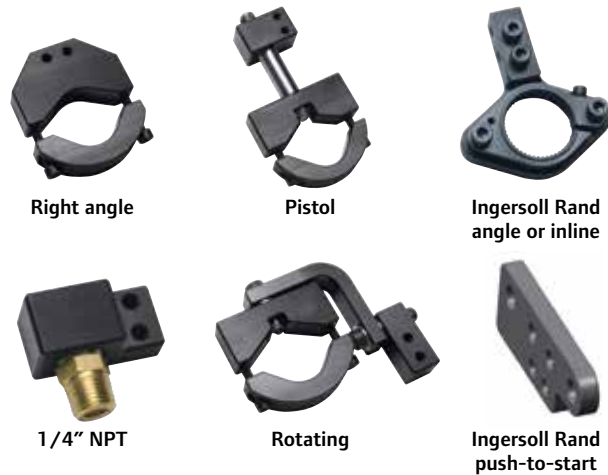

TORQUE ARMS				
Tool Holder	QTA010	QTA020	QTA040	QTA100
<b>GENERIC CLAMP STYLE TOOL HOLDERS</b>				
Inline (included with arm)	ITC010-1C	ITC040-1C	ITC040-1C	ITC100-1C
Right angle	ATC010-1C	ATC040-1C	ATC040-1C	ATC100-1C
Pistol	PTC010-1C	PTC040-1C	PTC040-1C	N/A
Rotating	RTC010-1C	RTC040-1C	RTC040-1C	N/A
1/4" NPT	NTC010-1T	N/A	N/A	N/A

Generic Tool holders are not available for arms 150 Nm and above

Flange mounting is recommended for inline tools with torque capacity above 40 Nm

Please note the tool diameter range for generic holders:

QTA010: 25 – 40 mm (1" – 1.57")  
 QTA020 / QTA040 / QTA100:  
 28 – 52 mm (1.1" – 2")

TORQUE ARMS							
TOOLS	QTA010	QTA020	QTA040	QTA100	QTA150	QTA270	QTA475
<b>INGERSOLL RAND QA SERIES AND QE SERIES TOOL HOLDERS</b>							
QE4 (non-push to start)	N/A	CTC040-K1B	CTC040-K1B	N/A	N/A	N/A	N/A
QE4 (push to start)	CTC040-K1P	CTC040-K1P	CTC040-K1P	N/A	N/A	N/A	N/A
QE6	N/A	CTC040-K2B	CTC040-K2B	CTC100-K2B	N/A	N/A	N/A
QE8 (using bolt-on flange GEM120-K48)	N/A	N/A	N/A	CTC100-K2B	CTC150-K2B	N/A	N/A
QE8 (using integrated flanged gear case)	N/A	N/A	N/A	CTC100-K3B	CTC150-K3B	CTC270-K3B	N/A
QE8 (230 Nm inline)	N/A	N/A	N/A	N/A	N/A	CTC270-K4B	N/A
QE8 (400 Nm angle)	N/A	N/A	N/A	N/A	N/A	N/A	CTC475-K5B
QA4 (angle)	N/A	CTC040-K6B	CTC040-K6B	CTC100-K6B	N/A	N/A	N/A
QA4 (27 Nm max inline) & QA6	N/A	CTC040-K1B	CTC040-K1B	CTC100-K1B	N/A	N/A	N/A
QA4 (46 Nm inline)	N/A	N/A	N/A	CTC100-K2B	N/A	N/A	N/A
QA8 (150 Nm max angle, 55 Nm max inline)	N/A	N/A	CTC040-K1B	CTC100-K1B	CTC150-K2B	N/A	N/A
QA8 (above 150 Nm angle, above 55 Nm inline)	N/A	N/A	N/A	CTC100-K2B	CTC150-K3B	CTC270-K3B	N/A

Note: Every Ingersoll Rand QE- or QA-specific tool holder listed in the table above accepts both angle and inline tools but requires an integrated flanged gear case or bolt-on mounting flange to attach the tool holder to the tool. If your tool came with mounting style "P," "R," or "J," order Part No. 15E4-K48 for any Ingersoll Rand-specific tool holder that ends with "1B." Order Part No. GEM120-K48 for any Ingersoll Rand-specific tool holder that ends with "2B." Order Part No. QA4-K48 for any Ingersoll Rand-specific tool holder that ends with "6B."

# Workstations & Torque Tubes

## Light-Duty Workstations

These steel-constructed, lightweight workstations offer the operator flexibility while supporting the tool weight. Add a torque absorber rod to help relieve minor torque reaction.

Model	Description
IRBS3-E0	Basic station (no absorber)
IRBS3-N30	Air tool station with torque absorber
IRBS3-E30	Electric tool station with torque absorber

Note: Workstations do not include tool, spring balancer, air hose, or FRL. All must be purchased separately.



## Torque Tubes

Model	Description	ft-lbs (Nm)	SWL lbs (kg)	lbs (kg)	in (mm)
54044227	IRZ-TT-100	74 (100)	60 (27)	40 (18)	20" (508)
54041819	IRZ-TT-250	184 (250)	60 (27)	50 (23)	24" (610)
54044417	IRZ-TT-500*	368 (500)	400 (182)	75 (34)	36" (914)

\* Requires carriage mount. See form # MHD55226 for more details.

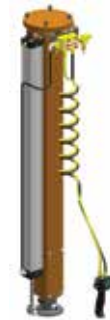

## Spindle Accessories

### Drive Guides and Magnetic Bit Holders



Part Number	Size
3HXDRGD	3" drive guide
2HXMGBH	2" bit holder
3HXMGBH	3" bit holder

### Hex to Square Adapters



Model	Size
1/4HXSQAD	1/4" sq
3/8HXSQAD	3/8" sq

### Power Screwdriver Adapters

Part Number	Bit Size	Square Drive
2U-812	5/16" square	3/8"
4U-812	5/16" square	1/2"
POWER SQUARE INSERT BIT FOR POWER ADAPTERS		
SPB082-5	Phillips bit	2
SPB083-5	Phillips bit	3
SPB084-5	Phillips bit	4

### Power Universal Joints



Part Number	Input Drive (Square)	Output Drive (Square)
J3	3/8"	3/8"
J4	1/2"	1/2"
J6	3/4"	3/4"

### Power Socket Adapters



Part Number	Drive Size Female	Male
A2F3M	1/4"	3/8"
A3F2M	3/8"	1/4"
A3F4M	3/8"	1/2"
A4F3M	1/2"	3/8"

### Power Driver Extensions

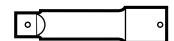

Part Number	Drive (Square)	Length
E33H	3/8"	3
E36H	3/8"	6
E43H	1/2"	3
E45H	1/2"	5
E63H	3/4"	3

Please see the Sockets brochure, form # IR-0506-016, for complete line of impact sockets.

# Spindle Accessories

## Phillips Bits



Part Number	Size
<b>1" STANDARD</b>	
1DBPH	1
2DBPH	2
<b>2" POWER BITS</b>	
1HXPB	1
2HXPB	2
3HXPB	3
<b>3" POWER BITS</b>	
2HXPH3L	2

## Slotted Bits



Part Number	Size
<b>1" STANDARD</b>	
T10DBTXR	T10
T15DBTXR	T15
T20DBTXR	T20
T25DBTXR	T25
<b>2" POWER BITS</b>	
6HXSL	6
8HXSL	8
10HXSL	10

## Magnetic Nutsetters

2" power bits



Part Number	Size
<b>STANDARD</b>	
5/32HXNS-E	5/32"
3/16HXNS-E	3/16"
7/32HXNS-E	7/32"
1/4HXNS-E	1/4"
9/32HXNS-E	9/32"
5/16HXNS-E	5/16"
11/32HXNS-E	11/32"
3/8HXNS-E	3/8"
7/16HXNS-E	7/16"
1/2HXNS-E	1/2"
<b>METRIC</b>	
5.5HXNS-M	5.5 mm
6HXNS-M	6 mm
7HXNS-M	7 mm
8HXNS-M	8 mm
9HXNS-M	9 mm
10HXNS-M	10 mm
11HXNS-M	11 mm
12HXNS-M	12 mm
13HXNS-M	13 mm

## Torx Bits

2" power bits



Part Number	Size
<b>1" STANDARD</b>	
6DBSL	6
8DBSL	8
<b>2" POWER BITS</b>	
T5HXTX	T5
T6HXTX	T6
T7HXTXR	T7
T8HXTXR	T8
T9HXTXR	T9
T10HXTXR	T10
T15HXTXR	T15
T20HXTXR	T20
T25HXTXR	T25
T30HXTXR	T30
T40HXTXR	T40

## Allen Bits



Part Number	Size
<b>1" STANDARD</b>	
1/8DBAL-E	1/8"
9/64DBAL-E	9/64"
5/32DBAL-E	5/32"
3/16DBAL-E	3/16"
1/4DBAL-E	1/4"
<b>2" POWER MAGNETIC</b>	
1/16HXAL-E	1/16"
5/64HXAL-E	5/64"
3/32HXAL-E	3/32"
7/64HXAL-E	7/64"
1/8HXAL-E	1/8"
9/64HXAL-E	9/64"
5/32HXAL-E	5/32"
3/16HXAL-E	3/16"
7/32HXAL-E	7/32"
1/4HXAL-E	1/4"
<b>2" METRIC POWER MAGNET</b>	
1.5HXAL-M	1.5 mm
2HXAL-M	2 mm
2.5HXAL-M	2.5 mm
3HXAL-M	3 mm
4HXAL-M	4 mm
5HXAL-M	5 mm
6HXAL-M	6 mm
7HXAL-M	7 mm
8HXAL-M	8 mm

# Torque Table Guide

*Suggested Tightening  
Torque Values for Nonferrous  
Threaded Fasteners*

## Torque Table

The following suggested tightening torques provide an excellent starting point for determining torque requirements. Remember, you may need to increase or reduce these numbers based on the individual joint.

Bolt Size	18-8 Stainless Steel	Brass	Silicon Bronze	Aluminum 2024-T4	316 Stainless Steel	Monel	Nylon
<b>VALUES (IN-LBS)</b>							
2 – 56	2.5	2.0	2.3	1.4	2.6	2.5	0.44
2 – 64	3.0	2.5	2.8	1.7	3.2	3.1	
3 – 48	3.9	3.2	3.6	2.1	4.0	4.0	
3 – 56	4.4	3.6	4.1	2.4	4.6	4.5	
4 – 40	5.2	4.3	4.8	2.9	5.5	5.3	1.19
4 – 48	6.6	5.4	6.1	3.6	6.9	6.7	
5 – 40	7.7	6.3	7.1	4.2	8.1	7.8	
5 – 44	9.4	7.7	8.7	5.1	9.8	9.6	
6 – 32	9.6	7.9	8.9	5.3	10.1	9.8	2.14
6 – 40	12.1	9.9	11.2	6.6	12.7	12.3	
8 – 32	19.8	16.2	18.4	10.8	20.7	20.2	4.30
8 – 36	22.0	18.0	20.4	12.0	23.0	22.4	
10 – 24	22.8	18.6	21.2	13.8	23.8	25.9	6.61
10 – 32	31.7	25.9	29.3	19.2	33.1	34.9	8.20
1/4" – 20	75.2	61.5	68.8	45.6	78.8	85.3	16.00
1/4" – 28	94.0	77.0	87.0	57.0	99.0	106.0	20.80
5/16" – 18	132.0	107.0	123.0	80.0	138.0	149.0	34.90
5/16" – 24	142.0	116.0	131.0	86.0	147.0	160.0	
3/8" – 16	236.0	192.0	219.0	143.0	247.0	266.0	
3/8" – 24	259.0	212.0	240.0	157.0	271.0	294.0	
7/16" – 14	376.0	317.0	349.0	228.0	393.0	427.0	
7/16" – 20	400.0	327.0	371.0	242.0	418.0	451.0	
1/2" – 13	517.0	422.0	480.0	313.0	542.0	584.0	
1/2" – 20	541.0	443.0	502.0	328.0	565.0	613.0	
9/16" – 12	682.0	558.0	632.0	413.0	713.0	774.0	
9/16" – 18	752.0	615.0	697.0	456.0	787.0	855.0	
5/8" – 11	1110.0	907.0	1030.0	715.0	1160.0	1330.0	
5/8" – 18	1244.0	1016.0	1154.0	798.0	1301.0	1482.0	
3/4" – 10	1530.0	1249.0	1416.0	980.0	1582.0	1832.0	
3/4" – 16	1490.0	1220.0	1382.0	958.0	1558.0	1790.0	
7/8" – 9	2328.0	1905.0	2140.0	1495.0	2430.0	2775.0	
7/8" – 14	2318.0	1895.0	2130.0	1490.0	2420.0	2755.0	
1" – 8	3440.0	2815.0	3185.0	2205.0	3595.0	4130.0	
1" – 14	3110.0	2545.0	2885.0	1995.0	3250.0	3730.0	
1-1/8" – 7	413.0 ft-lbs	337.0 ft-lbs	383.0 ft-lbs	265.0 ft-lbs	432.0 ft-lbs	499.0 ft-lbs	
1-1/8" – 12	390.0 ft-lbs	318.0 ft-lbs	361.0 ft-lbs	251.0 ft-lbs	408.0 ft-lbs	470.0 ft-lbs	
1-1/4" – 7	523.0 ft-lbs	428.0 ft-lbs	485.0 ft-lbs	336.0 ft-lbs	546.0 ft-lbs	627.0 ft-lbs	
1-1/4" – 12	480.0 ft-lbs	349.0 ft-lbs	447.0 ft-lbs	308.0 ft-lbs	504.0 ft-lbs	575.0 ft-lbs	
1-1/2" – 6	888.0 ft-lbs	727.0 ft-lbs	822.0 ft-lbs	570.0 ft-lbs	930.0 ft-lbs	1064.0 ft-lbs	
1-1/2" – 12	703.0 ft-lbs	575.0 ft-lbs	651.0 ft-lbs	450.0 ft-lbs	732.0 ft-lbs	840.0 ft-lbs	

*This table is offered as the suggested maximum torquing values for threaded products and is only a guide. Actual tests were conducted on dry or near-dry products. Mating parts were wiped clean of chips and foreign matter. A lubricated bolt requires less torque to attain the same clamping force as a non lubricated bolt. All values shown on chart except for nylon represent a safe working torque; in the case of nylon only, the figures represent breaking torque.*







Ingersoll Rand (NYSE:IR) advances the quality of life by creating comfortable, sustainable and efficient environments. Our people and our family of brands—including Club Car®, Ingersoll Rand®, Thermo King® and Trane®—work together to enhance the quality and comfort of air in homes and buildings; transport and protect food and perishables; and increase industrial productivity and efficiency. We are a \$12 billion global business committed to a world of sustainable progress and enduring results.



[www.ingersollrandproducts.com](http://www.ingersollrandproducts.com)

Distributed by:

Ingersoll Rand, IR and the IR logo are trademarks of Ingersoll Rand, its subsidiaries and/or affiliates. All other trademarks are the property of their respective owners. Nothing contained on these pages is intended to extend any warranty or representation, expressed or implied, regarding the product described herein. Any such warranties or other terms and conditions of sale of products shall be in accordance with Ingersoll Rand's standard terms and conditions of sale for such products, which are available upon request.

Product improvement is a continuing goal at Ingersoll Rand. Designs and specifications are subject to change without notice or obligation.